

Smart-Web Switches

ZX510S-4T2XS

Web Manual

Ver. 1.1

Revision history

Date	Version	Description
Jan. 09, 2025	V 1.0	The first edition

Contents

Smart-Web Switches.....	1
ZX510S-4T2XS.....	1
Web Manual.....	1
Ver. 1.1.....	1
Contents.....	3
1 Foreword.....	7
1.1 Target Audience.....	7
1.2 Manual Convention.....	7
2 Web Page Login.....	7
2.1 Log in the Network Management Client.....	7
2.2 Constitution of Client Interface.....	8
2.3 Navigation Bar on Web Interface.....	8
3 Status.....	12
3.1 System Information.....	12
3.2 Statistics.....	13
3.3 MAC Address Table.....	14
3.4 Reboot.....	14
4 Network.....	15
4.1 IP Address.....	15
4.2 DNS.....	15
4.3 System Time.....	17
5 Port.....	18
5.1 Port Setting.....	18
5.2 Link Aggregation.....	20
5.2.1 Group.....	21
5.2.2 Port Setting.....	23
5.2.3 LACP.....	23
5.3 EEE.....	26
5.4 Jumbo Frame.....	27

5.5 Port Security.....	27
5.6 Protected Port.....	28
5.7 Storm Control.....	29
5.8 Mirroring.....	30
6 VLAN.....	32
6.1 VLAN.....	33
6.1.1 Create VALN.....	33
6.1.2 VLAN Configuration.....	35
6.1.3 Membership.....	35
6.1.4 Port Setting.....	36
7 MAC Address Table.....	38
7.1 Static Address.....	39
7.2 Filtering Address.....	39
8 Spanning Tree.....	40
8.1 Property.....	41
8.2 Port Setting.....	42
8.3 MST Instance.....	44
8.4 MST Port Setting.....	45
8.5 Statistics.....	50
9 ERPS.....	50
9.1 Property.....	50
9.2 ERPS Instance.....	51
10 Loopback.....	53
11 Discovery.....	54
11.1 LLDP.....	55
11.2 Port Setting.....	56
11.3 MED Network Policy.....	58
11.4 MED Port Setting.....	59
11.5 Packet View.....	61
11.6 Local Information.....	61

11.7 Neighbor.....	62
11.8 Statistics.....	62
12 Multicast.....	63
12.1 General.....	63
12.1.1 Property.....	63
12.1.2 Group Address.....	63
12.1.3 Router Port.....	64
12.2 IGMP Snooping.....	65
12.2.1 Property.....	65
13 Security.....	67
13.1 Management Access.....	67
13.1.1 Management Service.....	67
13.2 DHCP Snooping.....	67
13.2.1 Property.....	68
13.2.2 IMPV Binding.....	69
14 QoS.....	70
14.1 General.....	72
14.1.1 Property.....	72
14.1.2 Queue Scheduling.....	73
14.1.3 CoS Mapping.....	74
14.1.4 DSCP Mapping.....	75
14.2 Rate limit.....	77
14.2.1 Ingress / Egress Port.....	77
15 Diagnostics.....	78
15.1 Ping.....	78
15.2 Copper Test.....	79
15.3 Fiber Module.....	79
16 Management.....	80
16.1 User Account.....	80
16.2 Firmware.....	81

16.3 Configuration.....	81
16.3.1 Manual Upgrade.....	81
16.3.2 Save Configuration.....	82
16.4 SNMP.....	83
16.4.1 View.....	84
16.4.2 Group.....	85
16.4.3 Community.....	86
16.4.4 User.....	87
16.4.5 Engine ID.....	88
16.4.6 Trap Event.....	89
16.4.7 Notification.....	89

1 Foreword

1.1 Target Audience

This manual is prepared for the installers and system administrators who are responsible for network installation, configuration and maintenance. It assumes that the user has understood all network communication and management protocols, as well as the technical terms, theoretical principles, practical skills, and expertise of devices, protocols and interfaces related to networking. Work experience in Graphical User Interface (GUI), Command-line Interface, Simple Network Management Protocol (SNMP) and Web Explorer is also required.

1.2 Manual Convention

The following approaches should prevail.

GUI Convention	Description
Interpretation	Describe operations and add necessary information.
 Caution	Remind the user of cautions as improper operations will result in data loss or equipment damage.

2 Web Page Login

2.1 Log in the Network Management Client

Type in the default switch address: **http://192.168.2.1** and press “Enter”.



Description:

Browser standards: superior to IE 9.0, Chrome 23.0 and Firefox 20.0

Keep the IP network segment of PC consistent with that of switch but differentiate the IP address as you log in. Set PC's IP address of 192.168.2.x and the subnet mask of 255.255.255.0 for the first login ($1 < x \leq 254$).

A login window appears as follows. Type in the default username of “**admin**” and

the password of “admin”. Click the “Log in” to see the switch system.

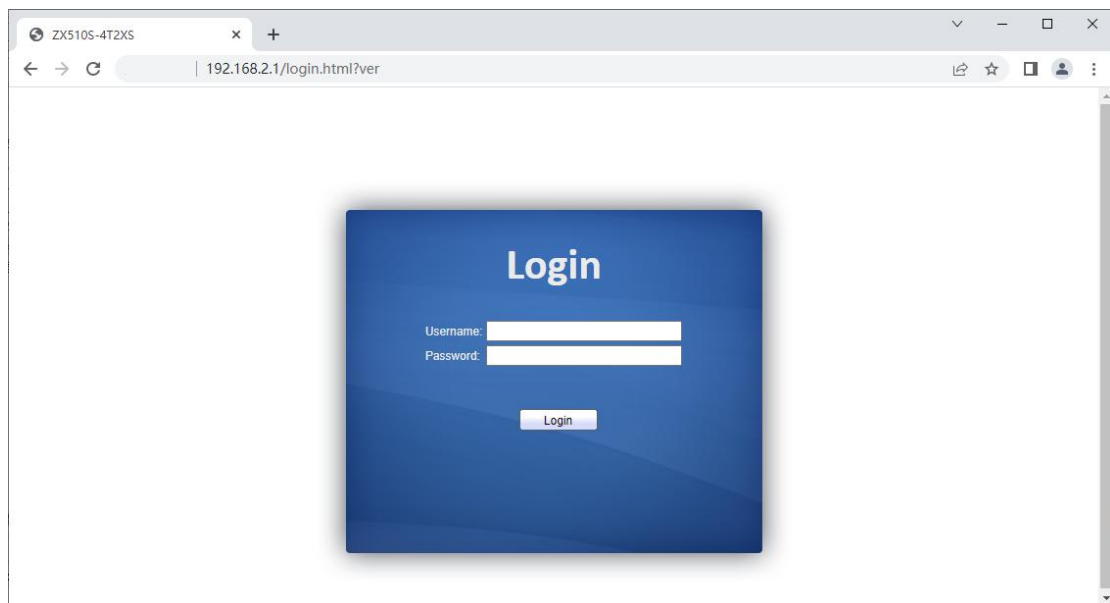

2.2 Constitution of Client Interface

The typical operation interface of Web network management system is as follows.

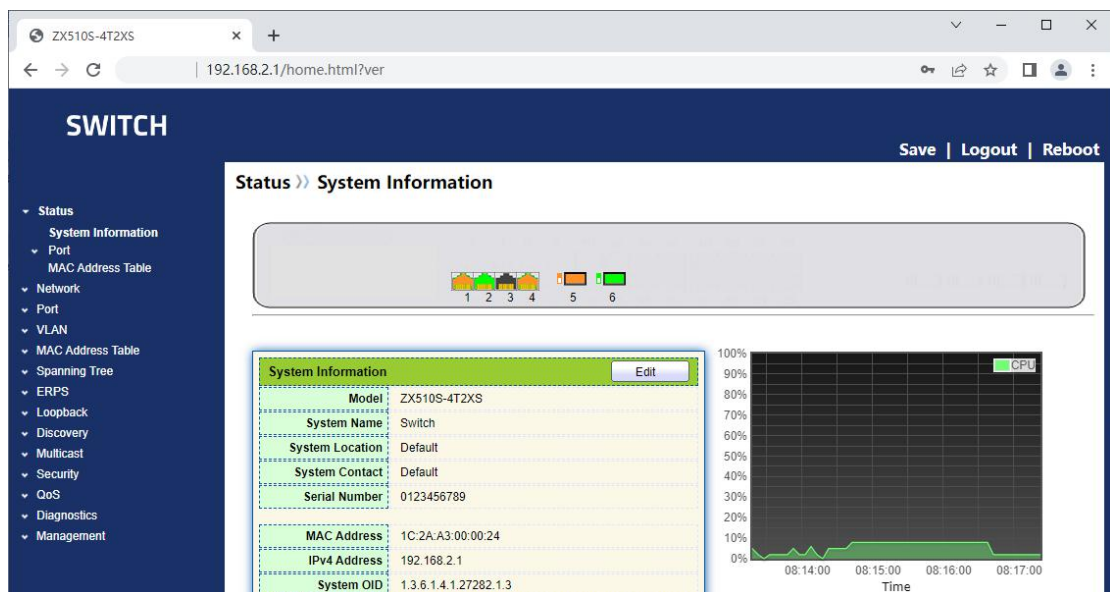

2.3 Navigation Bar on Web Interface

Menu items such as Status, Network, Port, VLAN, MAC Address Table, Spanning Tree, ERPS, Loopback, Discovery, Multicast, Security, QoS, Diagnostics and Management are available on the web network management client. Each item contains submenus.

Navigation bar is detailed as follows:

Menu Items	Submenus	Secondary Submenus	Description
Status	System Information		Display the port state and product info
	Port	Statistics	Display the detailed port statistics
	MAC Address Table		Display the MAC address table of the current device
Network	IP Address		Configure and view the management IP address
	DNS		Configure and view the DNS and server setting
	System Time		Configure and view the current system time
Port	Port Setting		Configure and view all ports
	Link Aggregation	Group	Configure and view the port & strategy balancing algorithms contained in LAG
		Port Setting	Configure and view the LAG
		LACP	Check LACP system priority and port configuration
	EEE		Configure and view the EEE state and information
	Jumbo Frame		Configure and view the length of the max message forwarded by system
	Port Security		Configure and view the rate limiting of port security, as well as port state
	Protected Port		Configure and view the port isolation
	Storm Control		Configure and view the port storm policing
	Mirroring		Configure and view the port mirroring
VLAN	VLAN	Create VLAN	Configure and view the VLAN info of the device
		VLAN Configuration	Configure and view the VLAN configuration of all ports
		Membership	Configure and view the port info of VLANs
		Port Setting	Configure and view the PVID and

			VLAN attributes of ports
MAC Address Table	Static Address		Configure and view the static MAC address tables of the device
	Filtering Address		Configure and view the MAC address tables to be filtered
Spanning Tree	Property		Configure and view the STP state and attributes
	Port Setting		Configure and view the port attributions of STP
	MST Instance		Configure and view the instance attributes of STPs
	MST Port Setting		Configure and view the instances (incl. port info) of STPs
	Statistics		Configure and view the STP message statistics of each port
ERPS	Property		Configure and view the ERPS global switch
	ERPS Instance		Configure and view the ERPS Instance
Loopback	Loopback Config		Configure and view the loopback configuration
Discovery	LLDP	Property	Configure and view the attributes related to LLDP
		Port Setting	Configure and view the transmitting & receiving state of LLDP at each port
		MED Network Policy	Configure and view the MED network strategy table entry
		MED Port Setting	Configure and view the MED state at each port
		Packet View	Configure and view the detailed LLDP messages at each port
		Local Information	Configure and view the LLDP and LLDP-MED state
		Neighbor	Configure and view the LLDP neighbor info
		Statistics	Configure and view the transmitting & receiving state of LLDP message at each port
Multicast	General	Property	Configure and view the function configuration

		Group Address	Configure and view the relevant static multicast info
		Router Port	Configure and view the multicast routed port info
	IGMP Snooping	Property	Configure and view the switch, version, etc.
Security	Management Access	Management Service	Configure and view the service management mode and relevant attributes
	DHCP Snooping	Property	Configure and view the switch and state
		IMPV Binding	View the binding tables of IP, MAC, Port and VLAN
QoS	General	Property	Configure and view the QoS switch and state
		Queue Scheduling	Configure and view the algorithm of queue scheduling
		CoS Mapping	Configure and view the priority and local queue mapping table
		DSCP Mapping	Configure and view the priority and local queue mapping table
	Rate Limit	Ingress/Egress Port	Configure and view the configuration of port rate limiting
Diagnostics	Ping		Network diagnostics by Ping
	Copper Test		Electrical interface link diagnostics by VCT
	Fiber Module		Check the SFP module at optical interfaces
Management	User Account		Configure and view the user info
	Firmware	Manual Upgrade	Update software
	Configuration	Manual Upgrade	Update configuration files
		Save Configuration	Save the configuration files supporting device running
	SNMP	View	Configure and view the SNMP function view table entry
		Group	Configure and view the SNMP group
		Community	Configure and view the SNMP Community
		User	Configure and view the SNMP user attributes

		Engine ID	Configure and view the SNMP and remote Engine IDs
		Trap Event	Configure and view the SNMP Trap switch and state
		Notification	Configure and view the SNMP Notification server state

3 Status

3.1 System Information

According to the switch connected, web network management panel directly displays the port and product info, incl.: number of ports, port states, product info, device states, function on-off states, etc.

Instructions:

1. Click the “Status > System Information” in the navigation bar as follows:

The screenshot shows a navigation bar with six port status icons labeled 1 through 6. Below it, the 'System Information' panel is displayed with the following details:

System Information Edit	
Model	ZX510S-4T2XS
System Name	Switch
System Location	Default
System Contact	Default
Serial Number	0123456789
<hr/>	
MAC Address	1C:2A:A3:00:00:24
IPv4 Address	192.168.2.1
System OID	1.3.6.1.4.1.27282.1.3
System Uptime	0 day, 0 hr, 31 min and 51 sec
Current Time	2025-01-01 08:31:36 UTC+8
<hr/>	
Firmware Version	1.1.1.30
Firmware Date	Jan 09 2025 - 02:53:13
<hr/>	
HTTP	Enabled
SNMP	Disabled

To the right of the system information are two performance graphs:

- CPU:** A line graph showing CPU usage percentage over time from 08:14:00 to 08:17:00. The usage remains very low, near 0%.
- MEM:** A line graph showing memory usage percentage over the same time period. The usage is consistently around 65-70%.

Description:

Mouseover a port to check the port No., type, rate and state. "Edit" the "System Name", "Location" and "Contact" in the product info. "Apply" and finish.

3.2 Statistics

Introduce the detailed flow statistics at a port and the info to be refreshed or cleared manually by users.

1. Click the "Status > Port > Statistics" in the navigation bar as follows:

The screenshot shows a configuration panel for port statistics. It includes a dropdown menu for the port (TE1), radio buttons for MIB Counter (All, Interface, Etherlike, RMON) and Refresh Rate (None, 5 sec, 10 sec, 30 sec), and a Clear button. Below the configuration panel is a table displaying the flow statistics for the selected port.

Interface	
ifInOctets	4206296095
ifInUcastPkts	475407066
ifInNUcastPkts	3310499630
ifInDiscards	0
ifOutOctets	2791189504412
ifOutUcastPkts	5087886513
ifOutNUcastPkts	3845755419
ifOutDiscards	0
ifInMulticastPkts	2116249609
ifInBroadcastPkts	1194250021
ifOutMulticastPkts	38145471202
ifOutBroadcastPkts	60022585

 Description:

"Clear" the flow statistics at the current port and refresh the page.

3.3 MAC Address Table

View MAC address table information

Instructions:

1. Click the “Status > MAC Address Table” in the navigation bar as follows:

MAC Address Table

Showing entries Showing 1 to 2 of 2 entries

VLAN	MAC Address	Type	Port
1	1C:2A:A3:00:00:24	Management	CPU
1	00:E0:4C:2E:2C:DD	Dynamic	TE4

Interface data are as follows.

Query Items	Description
MAC	Destination MAC Address
VLAN	VLAN ID belonging to MAC address
Port	Message egress corresponding to MAC address
Type	<p>Dynamic MAC Address refers to the entry which will age with the set aging time. Switches can add entries based on the learning mechanism of MAC address or manual creation.</p> <p>Static MAC address refers to the specified table which is manually configured and won't age.</p> <p>Management MAC address refers to the address at the management port.</p>

3.4 Reboot

1. Click the “Reboot” on the upper right as guided as follows.

Save | Logout | Reboot

Reboot the system and unsaved changes in the configuration will be lost. Do you want to continue?

4 Network

4.1 IP Address

Change the management IP address on web interface.

Instructions:

1. Click the "Network > IP Address" in the navigation bar to discover IPv4 address of 192.168.2.1/24 by default as follows

Management VLAN	
VLAN	<input type="text" value="1"/> (note: make sure add changing vlan to corresponding port before change)
IPv4 Address	
Address Type	<input checked="" type="radio"/> Static <input type="radio"/> Dynamic
IP Address	<input type="text" value="192.168.2.1"/>
Subnet Mask	<input type="text" value="255.255.255.0"/>
Default Gateway	<input type="text"/>

 **Note:**

- make sure add changing VLAN to corresponding port before change

4.2 DNS

DNS is short for Domain Name System to name computers and network services from units to domain hierarchies. A domain name consists of the dots separated by a series of words or abbreviations, each corresponding to a unique IP address. DNS is the server on the Internet that resolves domain names. Applicable to Internet and other TCP/IP networks, DNS name retrieves computers and services through user-friendly names. As one of the core Internet services, DNS is a distributed database that maps domain names and IP addresses mutually.

Instructions:

1. Click on the "Network > DNS" in the navigation bar as follows.

DNS Configuration

DNS Status	<input type="radio"/> Disable <input checked="" type="radio"/> Enable
DNS Default Name	<input type="text"/> (1 to 255 alphanumeric characters)

Apply

DNS Server Configuration

Q

<input type="checkbox"/>	Preference	DNS Server
0 results found.		

Add Delete

Interface data are as follows.

Configuration Items	Description
DNS State	DNS switch
DNS Default Name	Enter the DNS default name

2. "Add" to configure DNS server.

Add DNS Server

IPv4/IPv6 Address	<input type="text" value="114.114.114.114"/>
--------------------------	--

Apply Close

3. "Apply" and finish as follows.

DNS Server Configuration

Q

<input type="checkbox"/>	Preference	DNS Server
<input type="checkbox"/>	1	114.114.114.114

Add Delete

4.3 System Time

It is mainly used to configure the system time, and select the time source, daylight-saving time, etc.

Instructions

1. Click on the “Network > System Time” in the navigation bar as follows.

Source

SNTP
 From Computer
 Manual Time

Time Zone UTC +8:00

SNTP

Address Type Hostname
 IPv4

Server Address

Server Port (1 - 65535, default 123)

Manual Time

Date YYYY-MM-DD

Time HH:MM:SS

Daylight Saving Time

Type None
 Recurring
 Non-recurring
 USA
 European

Offset Min (1 - 1440, default 60)

Recurring

From: Day Week Month Time

To: Day Week Month Time

Non-recurring

From: YYYY-MM-DD HH:MM

To: YYYY-MM-DD HH:MM

Operational Status

Current Time 2025-01-01 08:22:28 UTC+8

Interface data are as follows.

Configuration Items	Description
Time Source	Select the time source in SNTP, PC or manual modes
Time Zone	Set the time zone
Address Type	Host name or IPv4 address (with time source set by SNTP)

Server Address	Server Address (with time source set by SNTP)
Server Port No.	Server Port No. (with time source set by SNTP)
Date	Date info: DD/MM/YYYY (with time source set in manual mode)
Time	Time info: SS/MM/HH (with time source set in manual mode)
Type	Daylight-saving time types are divided into None, cyclic, non-cyclic, United States and Europe.
Reimbursed Time	Reimbursed Time of daylight-saving time
Cyclic Mode	Configure the cyclic mode of daylight-saving time
Non-cyclic Mode	Configure the non-cyclic mode of daylight-saving time

5 Port

5.1 Port Setting

Interfaces should be identified so that users can inquire and configure Ethernet interfaces as they want.

Instructions:

1. Click the "Port > Port Setting" in the navigation bar:

Port Setting Table

<input type="checkbox"/>	Entry	Port	Type	Description	State	Link Status	Speed	Duplex	Flow Control
<input type="checkbox"/>	1	TE1	10G Copper		Enabled	Up	Auto (1000M)	Auto (Full)	Disabled (Off)
<input type="checkbox"/>	2	TE2	10G Copper		Enabled	Up	Auto (10G)	Auto (Full)	Disabled (Off)
<input type="checkbox"/>	3	TE3	10G Copper		Enabled	Down	Auto	Auto	Disabled
<input type="checkbox"/>	4	TE4	10G Copper		Enabled	Up	Auto (1000M)	Auto (Full)	Disabled (Off)
<input type="checkbox"/>	5	TE5	10G Fiber		Enabled	Up	Auto (1000M)	Auto (Full)	Disabled (Off)
<input type="checkbox"/>	6	TE6	10G Fiber		Enabled	Up	Auto (10G)	Auto (Full)	Disabled (Off)

2. Select the port(s) to be configured, and "Edit" as follows:

Edit Port Setting

Port	TE1-TE3
Description	<input type="text"/>
State	<input checked="" type="checkbox"/> Enable
Speed	<input checked="" type="radio"/> Auto <input type="radio"/> 100M <input type="radio"/> Auto - 100M <input type="radio"/> 1000M <input type="radio"/> Auto - 1000M <input type="radio"/> 2500M <input type="radio"/> Auto - 2500M <input type="radio"/> 5000M <input type="radio"/> Auto - 5000M <input type="radio"/> 10G <input type="radio"/> Auto - 10000M
Duplex	<input checked="" type="radio"/> Auto <input type="radio"/> Full <input type="radio"/> Half
Flow Control	<input type="radio"/> Auto <input type="radio"/> Enable <input checked="" type="radio"/> Disable

Interface data are as follows

Configuration Items	Description
Port	Port list
Description	Port alias
State	Enable or disable port
Speed	Configurable auto negotiation. Interface rates including 100 Mbit/s and 1,000 Mbit/s and 2500 Mbit/s and 5000 Mbit/s and 10 Gbit/s are available to Ethernet electrical interfaces and are optional as required.
Duplex	Configurable auto negotiation with full or half duplexes.
Flow Control	<p>After it is enabled on both local network and opposite network devices, the local one will notify the other to stop transmitting messages in the presence of network congestion. The opposite one will execute the command temporarily to ensure zero message loss.</p> <p>Disable-Disabled reception and transmission of PAUSE frame; Enable-Enabled reception and transmission of PAUSE frame; Auto negotiation-Negotiate PAUSE frame with opposite network devices automatically.</p>

5.2 Link Aggregation

Link Aggregation broadens bandwidth and reliability by bundling a group of physical interfaces into a single logical interface.

LAG (Link Aggregation Group) is a logical link bundled by multiple Ethernet links (Eth-Trunk).

Ceaselessly expanding network size increases users' demands of link bandwidth and reliability. Traditionally, high-speed interface board or the compatible equipment is usually replaced to optimize bandwidth, which is expensive and inflexible.

Link Aggregation Technology bundles multiple physical interfaces into a single logical interface without upgrading hardware. Its backup mechanism not only improves reliability, but also shares the flow load on different physical links.

As shown below, Switch A is linked with Switch B through three Ethernet links which are bundled into an Eth-Trunk logical link. Its bandwidth equals to that of the three links in total, thus broadening the bandwidth. Meanwhile, these three links back up mutually to be more reliable.

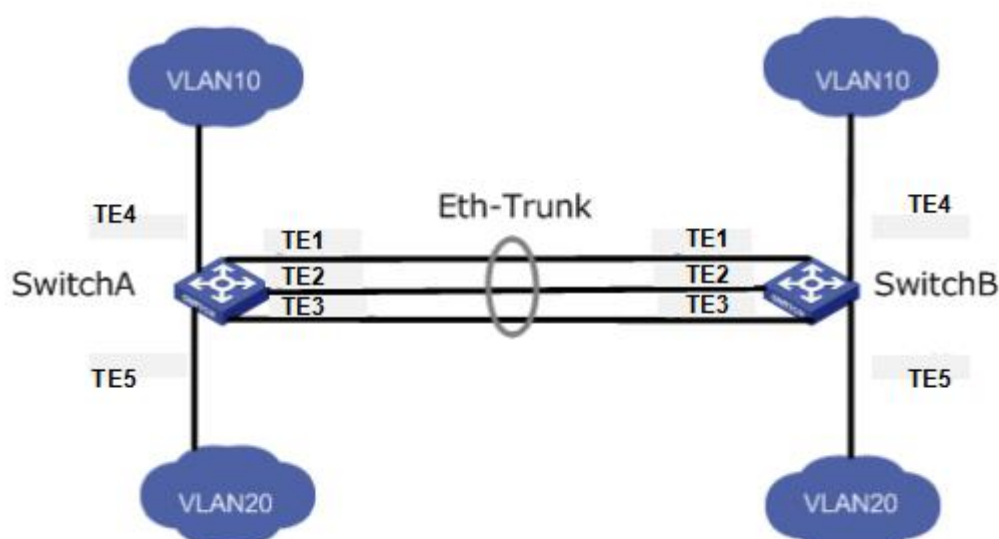

Link Aggregation can meet the following demands:

- Insufficient bandwidth of two switches connected with one link.
- Insufficient reliability of two switches connected with one link.

Link Aggregation can be divided into Manual Mode and LACP Mode in accordance with Link Aggregation Control Protocol (LACP) state.

In the first mode, Eth-Trunk establishment, member interface access should be added manually without LACP. It is also called the Load-sharing Mode because all links are involved in data forwarding and load sharing. In case any active link fails, LAG will average load with the remaining ones. This mode is preferred under the circumstance that two directly connected devices require a larger link bandwidth but has no access to

LACP.

5.2.1 Group

Instructions for adding a Static Link Aggregation:

1. Click the “Port > Link Aggregation > Group”, select a load-balancing algorithm with a radio button. “Apply” and finish as follows:

Load Balance Algorithm

MAC Address
 IP-MAC Address

Apply

Link Aggregation Table

Q

	LAG	Name	Type	Link Status	Active Member	Inactive Member	
<input type="radio"/>	LAG 1		---	---			
<input type="radio"/>	LAG 2		---	---			
<input type="radio"/>	LAG 3		---	---			
<input type="radio"/>	LAG 4		---	---			
<input type="radio"/>	LAG 5		---	---			
<input type="radio"/>	LAG 6		---	---			
<input type="radio"/>	LAG 7		---	---			
<input type="radio"/>	LAG 8		---	---			

Edit

2. Select one of 8 LAGs available, “Edit” the configuration page as follows:

Edit Link Aggregation Group

LAG 1

Name

Type
 Static
 LACP

Member

Available Port	Selected Port
TE1 TE2 TE3 TE4 TE5 TE6	<input type="text"/>

Apply Close

Interface data are as follows

Configuration Items	Description
LAG	There are 8 LAGs numbering from 1 to 8.
Name	Description of LAG, which can be modified as needed.
Type	Select from the manual mode and the LACP mode.
Member	Up to 8 member ports are available in LAG.

Illustration:

As shown below, Switch A and Switch B connect VLAN 10 and 20 via Ethernet respectively, with large data flow between them.

Both Switch A and B are expected to provide superior link bandwidth for VLAN communication. Meanwhile, there should be the redundancy for reliable data transmission and links.

Networking diagram LAG in manual mode

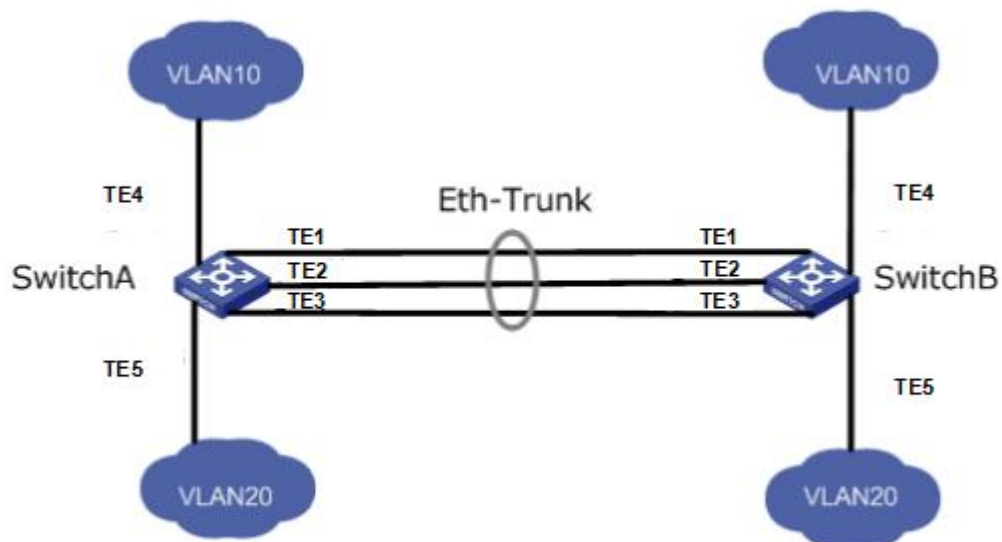

Instructions:

1. Create the ETH trunk interface in SwitchA and add a member interface to increase the link bandwidth. The configuration of SwitchB is like that of SwitchA. Click the "Port > Link Aggregation > Group", choose "LAG 1" and port TE1, 2 and 3 and move them to the selected ports on the right. "Apply" and finish as follows.

Link Aggregation Table

	LAG	Name	Type	Link Status	Active Member	Inactive Member
<input type="radio"/>	LAG 1		Static	Up	TE1	TE2-TE3
<input type="radio"/>	LAG 2		---	---		
<input type="radio"/>	LAG 3		---	---		

5.2.2 Port Setting

Attribute configuration of aggregation group member port

1. Click the "Port > Link Aggregation > Port Setting", to enter the attribute configuration interface of aggregation group member port as follows:

Port Setting Table

<input type="checkbox"/>	LAG	Type	Description	State	Link Status	Speed	Duplex	Flow Control
<input type="checkbox"/>	LAG 1			Enabled	Down	Auto	Auto	Disabled
<input type="checkbox"/>	LAG 2			Enabled	Down	Auto	Auto	Disabled
<input type="checkbox"/>	LAG 3			Enabled	Down	Auto	Auto	Disabled
<input type="checkbox"/>	LAG 4			Enabled	Down	Auto	Auto	Disabled
<input type="checkbox"/>	LAG 5			Enabled	Down	Auto	Auto	Disabled
<input type="checkbox"/>	LAG 6			Enabled	Down	Auto	Auto	Disabled
<input type="checkbox"/>	LAG 7			Enabled	Down	Auto	Auto	Disabled
<input type="checkbox"/>	LAG 8			Enabled	Down	Auto	Auto	Disabled

5.2.3 LACP

LACP (Link Aggregation Control Protocol), based on IEEE 802.3ad Standard, dynamically aggregates and dis-aggregates links. It exchanges info with the opposite network devices through LACPDU (Link Aggregation Control Protocol Data Unit).

After a port uses LACP, it will inform the opposite network device of system priority, system MAC, port priority and No., and operation Key by transmitting a LACPDU. The opposite device will compare such info with that saved by other ports after receiving it, thus reaching an agreement on port participation in or quitting from a dynamic

aggregation.

Dynamic LACP aggregation is automatically created or deleted by system, that is, internal ports can be added or removed by themselves. Only the ports connected to a same device with the same rate, duplex, and basic configuration can be aggregated.

Instructions for adding a dynamic link aggregation:

1. Click the “Port > Link Aggregation > Group” in the navigation bar, select the LAG ID and LACP mode, “Edit” them as follows:

Edit Link Aggregation Group

LAG 2

Name

Type Static LACP

Member

Available Port	Selected Port
TE1	TE4
TE2	TE5
TE3	TE6

Apply Close

2. Click the “Port > Link Aggregation > LACP” in the navigation bar to configure the LACP attributes such as system priority, port priority and timeout method as follows:

System Priority (1 - 65535, default 32768)

Apply

LACP Port Setting Table

<input type="checkbox"/>	Entry	Port	Port Priority	Timeout
<input type="checkbox"/>	1	TE1	1	Long
<input type="checkbox"/>	2	TE2	1	Long
<input type="checkbox"/>	3	TE3	1	Long
<input type="checkbox"/>	4	TE4	1	Long
<input type="checkbox"/>	5	TE5	1	Long
<input type="checkbox"/>	6	TE6	1	Long

Interface data are as follows

Configuration Items	Description
System Priority	LACP determines the active and passive modes between two devices subject to priority standard.
Port	Port list
Port Priority	LACP determines the dynamic LAG member mode subject to the port priority with a superior system.
Timeout	It decides the transmission frequency of LACP messages.

 Description:

Please make sure there is no member interface accessing the Eth-Trunk before changing its work pattern, otherwise it fails.

Work pattern of the local network devices should be consistent with that of the opposite network devices.

Illustration

Ethernet Switch A aggregates 3 ports from TE1 to TE3 to Switch B, in order to share the load by each member port.

The following configurations are exemplified by means of dynamic aggregation.

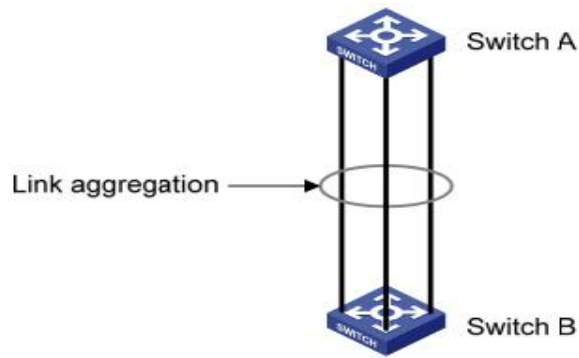

 Description:

The following is the configuration of Switch A only, which should stay the same with that of Switch B for port aggregation.

Instructions:

1. Click the “Port > Link Aggregation > Group” in the navigation bar, “Edit” with LAG 2, select TE1-TE3 in LACP mode. “Apply” and finish as follows:

Edit Link Aggregation Group

LAG	2	
Name	<input type="text"/>	
Type	<input checked="" type="radio"/> Static <input type="radio"/> LACP	
Member	Available Port TE4 TE5 TE6	Selected Port TE1 TE2 TE3

Apply Close

5.3 EEE

Port power will be turned down in case of zero or less flow

Instructions:

1. Click the “Port > EEE” in the navigation bar, select the port and “Edit” to enter the configuration interface as follows:

EEE Setting Table

Q

<input type="checkbox"/>	Entry	Port	Type	State
<input type="checkbox"/>	1	TE1	Copper	Disabled
<input type="checkbox"/>	2	TE2	Copper	Disabled
<input type="checkbox"/>	3	TE3	Copper	Disabled
<input type="checkbox"/>	4	TE4	Copper	Disabled
<input type="checkbox"/>	5	TE5	Copper	Disabled

2. Set the port enable tag and “Apply” to complete the configuration as follows:

EEE Setting Table

Q

<input type="checkbox"/>	Entry	Port	Type	State
<input type="checkbox"/>	1	TE1	Copper	Enabled
<input type="checkbox"/>	2	TE2	Copper	Enabled
<input type="checkbox"/>	3	TE3	Copper	Disabled
<input type="checkbox"/>	4	TE4	Copper	Disabled

5.4 Jumbo Frame

Set the MTU (Maximum Transmission Unit) of the port

Instructions:

1. Click the “Port > Jumbo Frame” in the navigation bar, enter Jumbo Frame configuration interface as follows:

Jumbo Frame Enable

Byte (1518 - 10000, default 1522)

5.5 Port Security

The port security feature records the Ethernet MAC address connected to the switch port through the MAC address table, and only one MAC address can communicate through this port. When packets sent by other MAC addresses pass through this port, port security features prevent it. Using port security features can prevent unauthorized devices from accessing the network and enhance security. In addition, port security features can also be used to prevent MAC address table from filling up due to MAC

address flooding

Instructions:

1. Click the “Port > Port Security” in the navigation bar, enter port security configuration interface as follows:

State Enable

Rate Limit Packet / Sec (1 - 600, default 100)

Apply

2. Click the “Port > Port Security” in the navigation bar, select the port and “Edit” to enter the port level configuration interface as follows:

Port Security Table

Q

<input type="checkbox"/>	Entry	Port	State	Address Limit	Total	Configured	Violate Number	Violate Action
<input type="checkbox"/>	1	TE1	Disabled	1	0	0	0	Protect
<input type="checkbox"/>	2	TE2	Disabled	1	0	0	0	Protect
<input type="checkbox"/>	3	TE3	Disabled	1	0	0	0	Protect
<input type="checkbox"/>	4	TE4	Disabled	1	0	0	0	Protect

5.6 Protected Port

Messages of broadcast, multicast, etc. will flood at each port even though the flow needs no mutual communication sometimes. Under this circumstance, port isolation can separate the messages between two ports.

Instructions:

1. Click the “Port > Protected Port” in the navigation bar, check the port(s) to be isolated, “Edit” to switch this function as follows:

Protected Port Table

Q

<input type="checkbox"/>	Entry	Port	State
<input type="checkbox"/>	1	TE1	Unprotected
<input type="checkbox"/>	2	TE2	Unprotected
<input type="checkbox"/>	3	TE3	Unprotected

Instructions for achieve port isolation:

1. Click the “Port > Protected Port” in the navigation bar, check and “Edit” the TE1, 2 and 3 to be isolated. “Apply” and finish as follows:

Protected Port Table

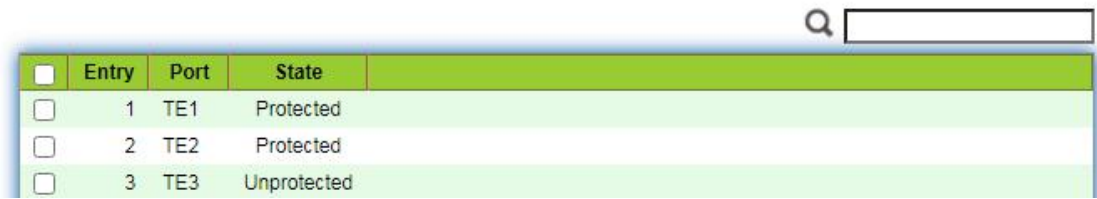

The image shows a table titled "Protected Port Table" with a search bar in the top right corner. The table has four columns: a checkbox, "Entry", "Port", and "State". There are three rows of data.

<input type="checkbox"/>	Entry	Port	State
<input type="checkbox"/>	1	TE1	Protected
<input type="checkbox"/>	2	TE2	Protected
<input type="checkbox"/>	3	TE3	Unprotected

2. TE1, 2 and 3 fail to communicate mutually like other non-isolated ports.

5.7 Storm Control

Storms generated via broadcast, unknown multicast and unicast messages are prevented as follows. These messages will be suppressed subject to packet rates respectively. The average rate of the messages received by monitoring interfaces will be compared with the max threshold configured during an inspection interval. Configured storm policing will be performed at this interface if the average rate exceeds the max threshold.

When a L2 Ethernet interface receives the broadcast, unknown multicast or unicast messages, the device will forward them to other L2 interfaces in a same VLAN (Virtual Local Area Network) if the egress interface cannot be recognized according to destination MAC addresses. As a result, broadcast storm may occur to degrade device operation performance.

Three kinds of message flow can be controlled by storm policing characteristics to stay away from broadcast storms.

Instructions:

1. Click the "Port > Storm Control" in the navigation bar to configure the attributes related to storm policing such as mode as follows:



The image shows a configuration form for storm control. It has two sections: "Mode" and "IFG".

Mode

- Packet / Sec
- Kbits / Sec

IFG

- Exclude
- Include

Apply

2. Select the appropriate port and "Edit" it by configuring the policing rates of broadcast, unknown multicast and unicast storms at each port.

Port Setting Table

<input type="checkbox"/>	Entry	Port	State	Broadcast		Unknown Multicast		Unknown Unicast		Action
				State	Rate (Kbps)	State	Rate (Kbps)	State	Rate (Kbps)	
<input type="checkbox"/>	1	TE1	Disabled	Disabled	10000	Disabled	10000	Disabled	10000	Drop
<input type="checkbox"/>	2	TE2	Disabled	Disabled	10000	Disabled	10000	Disabled	10000	Drop
<input type="checkbox"/>	3	TE3	Disabled	Disabled	10000	Disabled	10000	Disabled	10000	Drop

3. Configure info such as storm switch and rate, "Apply" and finish as follows:

Edit Port Setting

Port	TE1-TE2
State	<input checked="" type="checkbox"/> Enable
Broadcast	<input checked="" type="checkbox"/> Enable <input type="text" value="10000"/> Kbps (16 - 10000000, default 10000)
Unknown Multicast	<input checked="" type="checkbox"/> Enable <input type="text" value="10000"/> Kbps (16 - 10000000, default 10000)
Unknown Unicast	<input checked="" type="checkbox"/> Enable <input type="text" value="10000"/> Kbps (16 - 10000000, default 10000)
Action	<input checked="" type="radio"/> Drop <input type="radio"/> Shutdown

5.8 Mirroring

Port Mirroring copies the message of a specified switch port to the destination port. The copied port is the Source Port, and the copying port is the Destination Port. Destination Port accesses to data inspection devices so that users can analyze the messages received to monitor network and troubleshoot as follows:

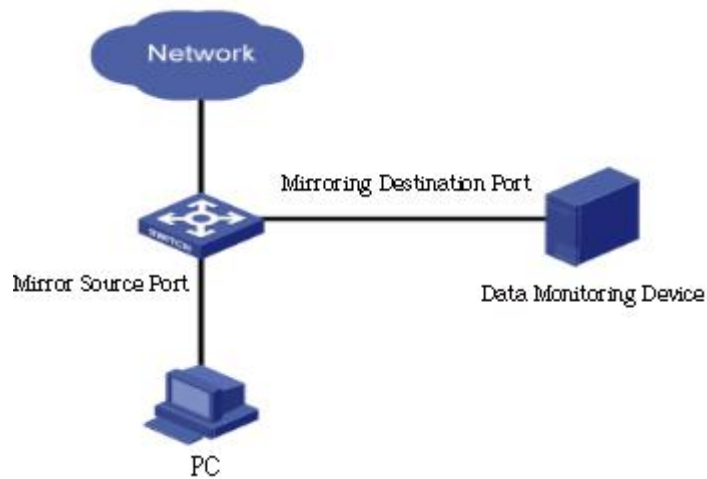

Instance

PC1 and PC2 access Switch A through interface TE1 and TE2 respectively. Users intend to monitor the messages transmitted from PC2 to PC1.

Instructions:

1. Click the "Port > Mirroring" in the navigation bar. 4 sets of flow mirroring rules can be configured as follows:

Mirroring Table

	Session ID	State	Monitor Port	Ingress Port	Egress Port
<input type="radio"/>	1	Disabled	---	---	---
<input type="radio"/>	2	Disabled	---	---	---
<input type="radio"/>	3	Disabled	---	---	---
<input type="radio"/>	4	Disabled	---	---	---

*** Allow the monitor port to send or receive normal packets

2. Select one session and "Edit" it in the mirroring group configuration interface:

Edit Mirroring

Session ID 1

State Enable

Monitor Port TE1

Send or Receive Normal Packet

Ingress Port

Available Port Selected Port

TE1
TE2
TE3
TE4
TE5
TE6
LAG1
LAG2

Egress Port

Available Port Selected Port

TE1
TE2
TE3
TE4
TE5
TE6
LAG1
LAG2

Apply Close

Interface data are as follows

Configuration Items	Description
Session ID	The switch has 4 session IDs by default.
State	The mirroring group can be enabled or not.
Monitor Port	Only one ordinary physical port can be selected, excluding link aggregation port and source port.
Ingress Port	Any message received will be mirrored to the destination port.
Egress Port	Any message transmitted will be mirrored to the destination port.

6 VLAN

VLAN is formulated not restricted to physical locations, which means the hosts in a same VLAN can be placed at will. As shown below, each VLAN, as a broadcast domain, divides a physical LAN into logical LANs. Hosts can exchange messages by means of

traditional communication. For the hosts in different VLANs, the device such as router or L3 switch is a must.

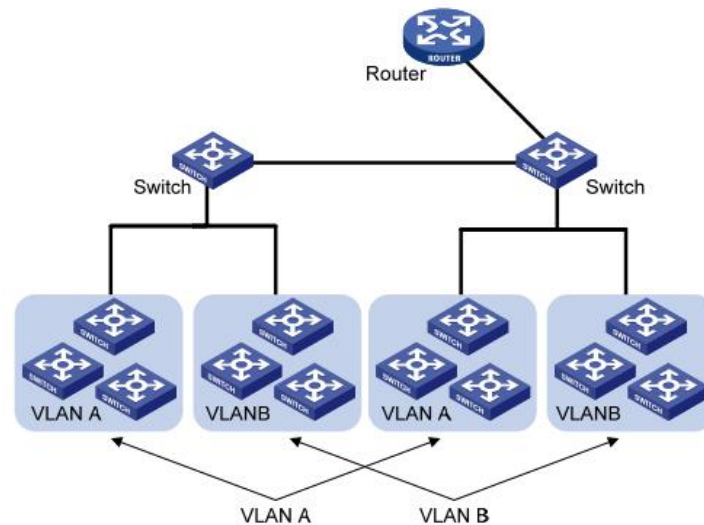

VLAN is superior to the traditional Ethernet in terms of:

- Broadcast domain coverage: the broadcast message in a LAN is limited in a VLAN to save the bandwidth and handle the network-related issues more efficiently.
- LAN security: VLAN hosts fail to communicate with each other since the messages are separated by the broadcast domain in the data link layer. They need a router or a Layer 3 switch for Layer 3 forwarding.
- Flexibility of creating a virtual working team: VLAN can create a virtual working team beyond the control of physical network. Users have access to the network without changing the configuration if their physical locations are moving within the scope. This management switch is compatible with VLAN types based on 802.1Q, protocols, MAC, and ports. For default configuration, 802.1Q VLAN mode should be adopted. Port VLAN is divided subject to a switch's interface No. Network administrator gives each switch interface a different PVID, namely a port default VLAN. If a data frame without a VLAN tag flows into a switch interface with a PVID, it will be marked with the same PVID, or it will get rid of an additional tag even though the interface has a PVID.
- The solution to a VLAN frame depends on the interface type, which eases member definition but re-configures VLAN in case of member mobility.

6.1 VLAN

6.1.1 Create VALN

Instructions for creating a new VLAN:

1. Click the "VLAN > VLAN > Create VLAN" to select a name in the valid VLAN box,

move it to the VLAN creating box on the right. “Apply” and finish as follows:

Apply

VLAN Table

Showing entries Showing 1 to 1 of 1 entries

VLAN	Name	Type	VLAN Interface State
1	default	Default	Disabled

2. The VLAN created will be displayed in the VLAN Table. Users can “Edit” the VLAN as follows:

Edit VLAN Name

Interface data are as follows.

Configuration Items	Description
VLAN ID	It is required to select an ID ranging from 1 to 4,094. For example, 1-3,5,7 and 9. LAN 1 is the default, which won't be repeated in another new VLAN.
Name	It is optional to modify the VLAN description as required.

6.1.2 VLAN Configuration

There are two methods. One is to add multiple ports under a single VLAN. The other is to add a port to multiple VLANs. They are configured according to different purposes.

Instructions for the first method to add the current port to a specified VLAN

1. Click the “VLAN > VLAN > VLAN Configuration” in the navigation bar, select the VLAN ID on the upper left, and then click the port info as follows:

VLAN Configuration Table

VLAN

Entry	Port	Mode	Membership			PVID	Forbidden
1	TE1	Trunk	<input type="radio"/> Excluded	<input type="radio"/> Tagged	<input checked="" type="radio"/> Untagged	<input checked="" type="checkbox"/>	<input type="checkbox"/>
2	TE2	Trunk	<input type="radio"/> Excluded	<input type="radio"/> Tagged	<input checked="" type="radio"/> Untagged	<input checked="" type="checkbox"/>	<input type="checkbox"/>
3	TE3	Trunk	<input type="radio"/> Excluded	<input type="radio"/> Tagged	<input checked="" type="radio"/> Untagged	<input checked="" type="checkbox"/>	<input type="checkbox"/>
4	TE4	Trunk	<input type="radio"/> Excluded	<input type="radio"/> Tagged	<input checked="" type="radio"/> Untagged	<input checked="" type="checkbox"/>	<input type="checkbox"/>
5	TE5	Trunk	<input type="radio"/> Excluded	<input type="radio"/> Tagged	<input checked="" type="radio"/> Untagged	<input checked="" type="checkbox"/>	<input type="checkbox"/>

Interface data are as follows.

Configuration Items	Description
VLAN	VLAN ID to be configured
Port	Port list
Mode	VLAN mode of port
Membership	Member roles at the VLAN port: Excluded: the port is out of this VLAN Tagged: the port is a tagged member of this VLAN Untagged: the port is an untagged member of this VLAN
PVID	Whether this VLAN is the port PVID
Forbidden	Whether the VLAN message is forbidden to be forwarded at this port

6.1.3 Membership

Instructions for the second method to add the current port to a specified VLAN

1. Click the “VLAN > VLAN > Membership” in the navigation bar, select the port to be configured and “Edit” to configure its attributes:

Membership Table

Entry	Port	Mode	Administrative VLAN	Operational VLAN	
<input type="radio"/>	1	TE1	Trunk	1UP	1UP
<input type="radio"/>	2	TE2	Trunk	1UP	1UP
<input type="radio"/>	3	TE3	Trunk	1UP	1UP

Interface data are as follows.

Configuration Items	Description
Port	Port list
Mode	VLAN mode of port
Membership	The port is the attribute of VLAN ID and VLAN: Forbidden: do not forward the VLAN message Excluded: the port out of the VLAN Tagged: The Tagged member of the VLAN Untagged: The Untagged member of the VLAN PVID: whether the VLAN is the port PVLAN

6.1.4 Port Setting

Trunk configuration. Connected with other switches, Trunk interfaces mainly connect trunk links to allow the VLAN frames to flow through. IEEE 802.1q is the encapsulation protocol of Trunk link and considers the formal standard for Virtual Bridged Local Area Networks. It changes the frame format of Ethernet by adding a 4-bit 802.1q Tag between the source MAC address field and the protocol field.

802.1q frame format

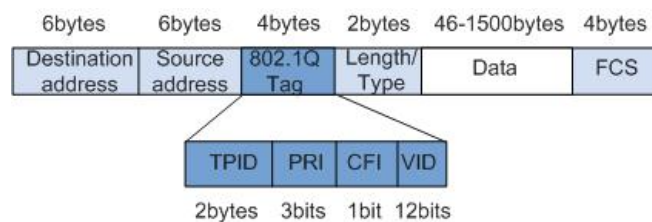

Meanings of 802.1q tag fields

Field	Length	Name	Analysis
TPID	2 bytes	Tag Protocol Identifier to describe the frame type	It refers to the 802.1q Tag frame when the value is 0x8,100, which will be discarded if relevant equipment fails to

			receive it.
PRI	3 bits	Frame Priority	It ranges from 0 to 7, with the higher priority represented by larger number. Data frame with higher priority will be sent preferentially in case of switch congestion.
CFI	1 bit	Canonical Format Indicator to reveal whether the MAC address is classical or not.	MAC address is classical when CFI is 0 and non-classical when CFI is 1. It promotes the compatibility between Ethernet and token ring. CFI will be 0 in the Ethernet.
VID	12 bits	VLAN ID indicates the VLAN to which the frame belongs.	It ranges from 0 to 4,095, with 1 to 4,094 valid since 0 and 4,095 are the protocol retention values.

Packets sent by each switch supporting 802.1q protocol contain a VLAN ID to indicate the VLAN to which the switch belongs. Therefore, Ethernet frames are divided into two types as follows in a VLAN switching network:

- Tagged frame: it refers to the frame adding a 4-bit 802.1q Tag.
- Untagged frame: it refers to the original frame without a 4-bit 802.1q Tag.

Connected with other switches, Trunk interfaces mainly connect trunk links to allow the VLAN frames to flow through.

Instructions for trunk interface configuration:

1. Click the "VLAN > VLAN > Port Setting" in the navigation bar, select the port and "Edit" it to configure the attributes:

Port Setting Table

<input type="checkbox"/>	Entry	Port	Mode	PVID	Accept Frame Type	Ingress Filtering	Uplink	TPID
<input type="checkbox"/>	1	TE1	Trunk	1	All	Enabled	Disabled	0x8100
<input type="checkbox"/>	2	TE2	Trunk	1	All	Enabled	Disabled	0x8100
<input type="checkbox"/>	3	TE3	Trunk	1	All	Enabled	Disabled	0x8100
<input type="checkbox"/>	4	TE4	Trunk	1	All	Enabled	Disabled	0x8100
<input type="checkbox"/>	5	TE5	Trunk	1	All	Enabled	Disabled	0x8100

Interface data are as follows.

Configuration Items	Description
Port	Port No. to be configured

Mode	VLAN mode of port Hybrid: port in this mode serves as the member of Tagged and Untagged ports of VLANs Access: port in this mode serves as the only member of VLAN Trunk: port in this mode serves as the only Untagged member of PVID and the Tagged member of VLANs Tunnel: Port Q-in-Q VLAN
PVID	Port native VLAN
Accept Frame Type	Message types received by ports All: all messages Tag Only: only Tagged messages will be received Untag Only: only Untagged messages will be received
Ingress Filtering	A switch to decide to filter VLAN messages excluded at the port
Uplink	Whether in uplink mode or not
TPID	Identification No. of VLAN Tag

7 MAC Address Table

Ethernet switches are mainly innovated to forward according to the purposes in the data link layer. That is, MAC address will transmit the messages to corresponding ports according to the purposes. MAC address forwarding table is a L2 table illustrating MAC addresses and forwarding ports, which is the basis of fast forwarding of L2 messages.

MAC address forwarding table contains following data:

- Destination MAC Address
- VLAN ID belonging to port
- Forwarding ingress No. of this device

There are two message forwarding types according to MAC address table info:

- Unicast mode: the switch directly transmits the messages from the table's egress when MAC address forwarding table contains corresponding entries with the destination MAC address.
- Broadcast mode: When the switch receives the messages with the destination address full of F-bits, or there is no entry corresponding to the MAC destination address in the forwarding table, the switch will forward the messages to all ports excluding the receiving port in this way.

7.1 Static Address

Static table is manually configured by users and distributed to each interface board, which won't age.

Instructions:

1. Click the "MAC Address Table > Static Address" as follows:

Static Address Table

Showing entries Showing 1 to 1 of 1 entries

<input type="checkbox"/>	VLAN	MAC Address	Port
<input type="checkbox"/>	1	00:00:11:11:22:22	TE1

First Previous **1** Next Last

Add Edit Delete

Interface data are as follows.

Configuration Items	Description
MAC	Required. Enter the new MAC address e.g.: HH:HH:HH:HH:HH:HH
VLAN	Required. Specify the VLAN ID
Port	Required. Select the interface type and enter the interface name Description: it must be the member port of the configured VLANs.

2. Fill in corresponding configuration items.
3. "Apply" and finish.

7.2 Filtering Address

The switch discards the matched data frame by configuration

Instructions:

1. Click the "MAC Address Table > Filtering Address" as follows:

Filtering Address Table

Showing entries Showing 0 to 0 of 0 entries

<input type="checkbox"/>	VLAN	MAC Address
0 results found.		

First Previous **1** Next Last

Add Edit Delete

Add Filtering Address

MAC Address	<input type="text"/>
VLAN	<input type="text"/> (1 - 4094)
<input type="button" value="Apply"/> <input type="button" value="Close"/>	

Interface data are as follows.

Configuration Items	Description
MAC Address	MAC address to be filtered
VLAN	VLAN of MAC address

8 Spanning Tree

Redundant links are often used for link backup and network reliability in the Ethernet switching network. However, such links will generate loops on the switching network, leading to broadcast storm, unstable MAC address list and other faults, thus worsening users' communication quality, or even interrupting the communication. As a result, STP (Spanning Tree Protocol) appears.

Same with the development of other protocols, from the original STP defined in IEEE 802.1D, to RSTP (Rapid Spanning Tree Protocol) defined in IEEE 802.1W and to MSTP (Multiple Spanning Tree Protocol) defined in IEEE 802.1S, STP keeps upgrading.

MSTP is compatible with RSTP and STP while RSTP is compatible with STP. The contrast among these 3 protocols is shown in the table.

The contrast among 3 protocols

STP	Characteristic	Application
STP	A tree rid of loops as the solution to broadcast storms and redundant backups. It converges slowly.	All VLANs can be shared without discrimination in user or business flow.
RSTP	A tree rid of loops as the solution to broadcast storms and redundant backups. It converges rapidly.	
MSTP	A tree rid of loops as the solution to broadcast storms and redundant backups. It converges rapidly. Spanning trees balance the load among VLANs. Flow of different VLANs will be	Distinguish the user and business flow for load sharing. Different VLANs forward the flow through separate spanning trees.

	forwarded subject to paths.	
--	-----------------------------	--

After STP is deployed, the following objectives can be achieved by calculating the loops with topology:

- Loop elimination: eliminate possible communication loops by blocking redundant links.
- Link backups: activate redundant links to restore network connectivity if the active path fails.

8.1 Property

Configure STP global parameters. In specific network environment, STP parameters of some devices must be adjusted to achieve the best performance.

Instructions:

1. Click the “Spanning Tree > Property” in the navigation bar as follows:

State	<input type="checkbox"/> Enable
Operation Mode	<input type="radio"/> STP <input checked="" type="radio"/> RSTP <input type="radio"/> MSTP
Path Cost	<input checked="" type="radio"/> Long <input type="radio"/> Short
BPDU Handling	<input type="radio"/> Filtering <input checked="" type="radio"/> Flooding
Priority	<input type="text" value="32768"/> (0 - 61440, default 32768)
Hello Time	<input type="text" value="2"/> Sec (1 - 10, default 2)
Max Age	<input type="text" value="20"/> Sec (6 - 40, default 20)
Forward Delay	<input type="text" value="15"/> Sec (4 - 30, default 15)
Tx Hold Count	<input type="text" value="6"/> (1 - 10, default 6)
Region Name	<input type="text" value="1C:2A:A3:00:00:24"/>
Revision	<input type="text" value="0"/> (0 - 65535, default 0)
Max Hop	<input type="text" value="20"/> (1 - 40, default 20)

Interface data are as follows.

Configuration Items	Description
State	It is checked by default to enable the spanning tree on behalf of switches.
Operation Mode	3 modes are available, namely STP, RSTP and MSTP.

Path Cost	In Long mode and Short mode
BPDU Handling	The method to handle the BPDU messages received by the device
Priority	Port priority
Hello Time	Intervals between Hello messages
Max Age	Max aging time
Forward Delay	Forward delay time
Tx Hold Count	Specify the Tx-hold-count used to limit the maximum numbers of packets transmission per second
Region Name	MST domain name. Switch master board sets the MAC address by default. Together with the VLAN mapping table of MST domain and the revision level of MSTP, switch domain name will jointly determine the domain to which it belongs.
Revision	The MSTP revision number
Max Hop	Specify the number of hops in an MSTP region before the BPDU is discarded

2. Fill in corresponding configuration items.
3. "Apply" and finish.

8.2 Port Setting

In specific network environment, STP parameters of some devices need to be adjusted for the best performance.

1. Click the "Spanning Tree > Port Setting" in the navigation bar, select the port and "Edit" to configure its attributes:

Port Setting Table

Entry	Port	State	Path Cost	Priority	BPDU Filter	BPDU Guard	Operational Edge	Operational Point-to-Point	Port Role	Port State	Designated Bridge	Designated Port ID	Designated Cost
1	GE1	Enabled	20000	128	Disabled	Disabled	Disabled	Disabled	Disabled	Disabled	0-00:00:00:00:00:00	128-1	20000
2	GE2	Enabled	20000	128	Disabled	Disabled	Disabled	Disabled	Disabled	Disabled	0-00:00:00:00:00:00	128-2	20000
3	GE3	Enabled	200000	128	Disabled	Disabled	Disabled	Enabled	Disabled	Forwarding	0-00:00:00:00:00:00	128-3	200000
4	GE4	Enabled	20000	128	Disabled	Disabled	Disabled	Disabled	Disabled	Disabled	0-00:00:00:00:00:00	128-4	20000
5	GE5	Enabled	20000	128	Disabled	Disabled	Disabled	Disabled	Disabled	Disabled	0-00:00:00:00:00:00	128-5	20000
6	GE6	Enabled	20000	128	Disabled	Disabled	Disabled	Disabled	Disabled	Disabled	0-00:00:00:00:00:00	128-6	20000
7	GE7	Enabled	200000	128	Disabled	Disabled	Disabled	Enabled	Disabled	Forwarding	0-00:00:00:00:00:00	128-7	200000
8	GE8	Enabled	20000	128	Disabled	Disabled	Disabled	Disabled	Disabled	Disabled	0-00:00:00:00:00:00	128-8	20000

Edit Port Setting

Port	GE1
State	<input checked="" type="checkbox"/> Enable
Path Cost	<input type="text" value="0"/> (0 - 200000000) (0 = Auto)
Priority	128
Edge Port	<input type="checkbox"/> Enable
BPDU Filter	<input type="checkbox"/> Enable
BPDU Guard	<input type="checkbox"/> Enable
Point-to-Point	<input checked="" type="radio"/> Auto <input type="radio"/> Enable <input type="radio"/> Disable
Port State	Disabled
Designated Bridge	0-00:00:00:00:00:00
Designated Port ID	128-1
Designated Cost	20000
Operational Edge	False
Operational Point-to-Point	False

Apply Close

Interface data are as follows.

Configuration Items	Description
Port	The port No. to configure attributes
State	Enable STP or not
Path Cost	Enter the path cost value of the interface Use IEEE 802.1t Standard with the value ranging from 0 to 200,000,000
Priority	<p>Select the port priority with smaller value representing higher priority.</p> <p>Interface priority affects the role of the interface on the specified MSTI. On different MSTI, users can configure the priorities for a same interface. As a result, flow of different VLANs can be forwarded along physical links to achieve VLAN load sharing.</p> <p>Description: MSTP will recalculate the interface role and migrate its state when its priority changes.</p>
Edge Port	Rather than another switch or network segment, the edge port should be connected directly to user terminals. It can quickly transit to the forward state since topology changes create no loops. An edge port under configuration can be quickly transitioned to

	forward state by STP. To achieve this, it is recommended that Ethernet ports connected directly to user terminals should be configured as edge ports.
BPDU Filter	Enable BPDU Filter or not
BPDU Guard	Enable BPDU Guard or not. Unchecked by default. If BPDU Guard is enabled, the device will shut down the interfaces receiving BPDU and notify the NMS. Such interfaces can only be restored manually by network administrators.
Point-to-Point	Select enabled, shutdown, and auto modes. Auto mode: it indicates the connect state between the default auto inspection and point-to-point links. Enabled mode: it indicates the specific port is connected to the point-to-point links. Shutdown mode: it indicates the specific port fails to connect the point-to-point links.

2. Fill in corresponding configuration items.
3. "Apply" and finish.

8.3 MST Instance

A switching network is divided into multiple domains by MSTP, with independent spanning trees formed within each domain. Each Spanning Tree is called a MSTI (Multiple Spanning Tree Instance), and each domain is called a MST Region: Multiple Spanning Tree Region).

 Description:

An instance is a group of VLANs that reduces communication cost and resource utilization rate. Each instance, independently calculated with topology, can balance the load. VLANs with the same topology can be mapped to a same instance, and they are forwarded according to the port state in corresponding MSTP instances.

In simple terms, mapped to the specified MST instance, one or more VLANs are distributed to a spanning tree at a time.

Instructions:

1. Click the "Spanning Tree > MST Instance" in the navigation bar, "Edit" the selected spanning tree instances to be configured as follows:

MST Instance Table

MSTI	Priority	Bridge Identifier	Designated Root Bridge	Root Port	Root Path Cost	Remaining Hop	VLAN
<input type="radio"/>	0	32768	32768-1C:2A:A3:00:00:24	0-00:00:00:00:00:00	N/A	0	1-4094
<input type="radio"/>	1	32768	32768-1C:2A:A3:00:00:24	0-00:00:00:00:00:00	N/A	0	0
<input type="radio"/>	2	32768	32768-1C:2A:A3:00:00:24	0-00:00:00:00:00:00	N/A	0	0
<input type="radio"/>	3	32768	32768-1C:2A:A3:00:00:24	0-00:00:00:00:00:00	N/A	0	0
<input type="radio"/>	4	32768	32768-1C:2A:A3:00:00:24	0-00:00:00:00:00:00	N/A	0	0

Edit MST Instance Setting

MSTI	0
Priority	<input type="text" value="32768"/> (0 - 61440, default 32768)
Bridge Identifier	32768-1C:2A:A3:00:00:24
Designated Root Bridge	0-00:00:00:00:00:00
Root Port	
Root Path Cost	0
Remaining Hop	0

Interface data are as follows.

Configuration Items	Description
MSTI	Instance No. of spanning trees ranges from 0 to 15
VLAN	VLAN No. mapped from instances
Priority	Set the priority of a multiple of 4,096 for the specified instance, ranging from 0 to 65,535 with 32,768 as default.

2. Fill in corresponding configuration items.
3. "Apply" and finish as follows.

8.4 MST Port Setting

Instructions:

1. Click the "Spanning Tree > MST Port Setting" in the navigation bar, check the port to be modified from the list of all ports of the device, "Edit" to enter the detailed configuration interface as follows:

MST Port Setting Table

MSTI

Entry	Port	Path Cost	Priority	Port Role	Port State	Mode	Type	Designated Bridge	Designated Port ID	Designated Cost	Remaining Hop
<input type="checkbox"/>	1 GE1	20000	128	Disabled	Disabled	RSTP	Boundary	0-00:00:00:00:00:00	128-1	0	20
<input type="checkbox"/>	2 GE2	20000	128	Disabled	Disabled	RSTP	Boundary	0-00:00:00:00:00:00	128-2	0	20
<input type="checkbox"/>	3 GE3	20000	128	Disabled	Disabled	RSTP	Boundary	0-00:00:00:00:00:00	128-3	0	20
<input type="checkbox"/>	4 GE4	20000	128	Disabled	Disabled	RSTP	Boundary	0-00:00:00:00:00:00	128-4	0	20
<input type="checkbox"/>	5 GE5	20000	128	Disabled	Disabled	RSTP	Boundary	0-00:00:00:00:00:00	128-5	0	20
<input type="checkbox"/>	6 GE6	20000	128	Disabled	Disabled	RSTP	Boundary	0-00:00:00:00:00:00	128-6	0	20
<input type="checkbox"/>	7 GE7	20000	128	Disabled	Disabled	RSTP	Boundary	0-00:00:00:00:00:00	128-7	0	20
<input type="checkbox"/>	8 GE8	20000	128	Disabled	Forwarding	RSTP	Boundary	0-00:00:00:00:00:00	128-8	0	20
<input type="checkbox"/>	9 GE9	20000	128	Disabled	Disabled	RSTP	Boundary	0-00:00:00:00:00:00	128-9	0	20

Edit MST Port Setting

MSTI

Port

Path Cost (0 - 200000000) (0 = Auto)

Priority

Port Role Disabled

Port State Disabled

Mode RSTP

Type Boundary

Designated Bridge 0-00:00:00:00:00:00

Designated Port ID 128-1

Designated Cost 20000

Remaining Hop 20

Interface data are as follows.

Configuration Items	Description
MSTI	Select the instance for configuration through the drop-down box in the upper left.
Port	Select the port to be configured by users
Path Cost	Enter the path cost value of the interface Use IEEE 802.1t Standard with the value ranging from 0 to 200,000,000
Priority	Select the port priority with smaller value representing higher priority. Interface priority affects the role of the interface on the specified MSTI. On different MSTI, users can configure the priorities for a same interface. As a result, flow of different VLANs can be forwarded along physical links to achieve VLAN load sharing. Description: MSTP will recalculate the interface role and migrate its state when its priority changes.

Port Role	3 types of root ports, namely specified port, backup port and disabled port.
Port State	Including 3 states, namely Discarding, Forwarding and Disabled
Mode	Current STP mode
Type	The port types in the instance contain boundary and internal ports

- Fill in corresponding configuration items.
- “Apply” and finish.

Example of MSTP function configuration:

Switch A, B, C and D all run MSTP which introduces instances to share the load of VLAN10 and 20. MSTP can set up the VLAN mapping table to associate VLANs with spanning tree instances, and to map VLAN10 from instance 1 and VLAN20 from instance 2.

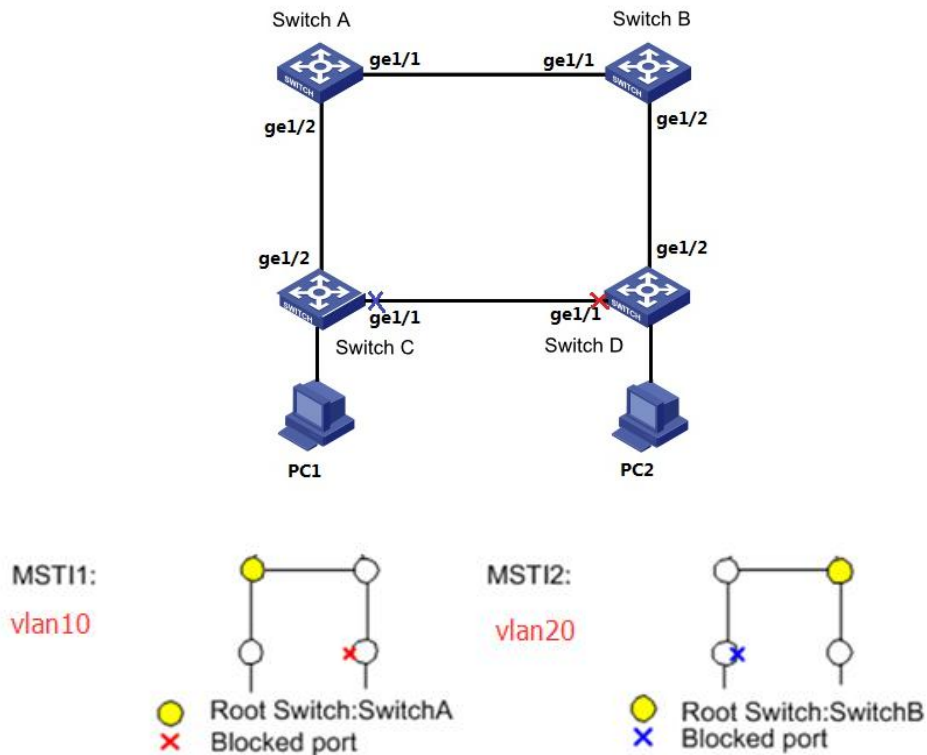

Instructions:

- Switch A, B, C and D create VLAN10 and 20 to configure the L2 forwarding function of the devices on the Ring. Click the “VLAN > VLAN > Create VLAN” in the navigation bar, fill in the corresponding configurations. “Apply” and finish as follows.

VLAN Table

Showing All entries Showing 1 to 3 of 3 entries

VLAN	Name	Type	VLAN Interface State
<input type="radio"/> 1	default	Default	Disabled
<input type="radio"/> 10	VLAN0010	Static	Disabled
<input type="radio"/> 20	VLAN0020	Static	Disabled

2. VLANs are added to the switch ports ingress loops. Click the “VLAN > VLAN > Membership” in the navigation bar, select the ring port to be configured, move VLAN10 and 20 to the right box and mark them with “Tagged”. “Apply” and finish:

Edit Port Setting

3. Click the “Spanning Tree > Property” in the navigation bar, and choose MSTP mode as follows:

State	<input checked="" type="checkbox"/> Enable
Operation Mode	<input type="radio"/> STP <input type="radio"/> RSTP <input checked="" type="radio"/> MSTP
Path Cost	<input checked="" type="radio"/> Long <input type="radio"/> Short
BPDU Handling	<input type="radio"/> Filtering <input checked="" type="radio"/> Flooding
Priority	<input type="text" value="32768"/> (0 - 61440, default 32768)
Hello Time	<input type="text" value="2"/> Sec (1 - 10, default 2)
Max Age	<input type="text" value="20"/> Sec (6 - 40, default 20)
Forward Delay	<input type="text" value="15"/> Sec (4 - 30, default 15)
Tx Hold Count	<input type="text" value="6"/> (1 - 10, default 6)
Region Name	<input type="text" value="1C:2A:A3:00:00:24"/>
Revision	<input type="text" value="0"/> (0 - 65535, default 0)
Max Hop	<input type="text" value="20"/> (1 - 40, default 20)

- Configure the VLAN mapping between instance MSTI1 and MSTI2. Click the "Spanning Tree > MST Instance" to fill in corresponding parameters, and "Add" them as follows:

MST Instance Table

MSTI	Priority	Bridge Identifier	Designated Root Bridge	Root Port	Root Path Cost	Remaining Hop	VLAN
<input type="radio"/>	0	32768-1C:2A:A3:00:00:24	0-00:00:00:00:00:00	N/A	0	0	1-9,11-19,21-4094
<input type="radio"/>	1	32768-1C:2A:A3:00:00:24	0-00:00:00:00:00:00	N/A	0	0	10
<input type="radio"/>	2	32768-1C:2A:A3:00:00:24	0-00:00:00:00:00:00	N/A	0	0	20
<input type="radio"/>	3	32768-1C:2A:A3:00:00:24	0-00:00:00:00:00:00	N/A	0	0	
<input type="radio"/>	4	32768-1C:2A:A3:00:00:24	0-00:00:00:00:00:00	N/A	0	0	
<input type="radio"/>	5	32768-1C:2A:A3:00:00:24	0-00:00:00:00:00:00	N/A	0	0	

 **Note:**

- Set the priority of MSTI1 to 0 and MSTI2 to 4,096 before configuring Switch A.
 - Set the priority of MSTI1 to 4,096 and MSTI2 to 0 before configuring Switch B.
 - The priority must be a multiple of 4,096.
- Switch B serves as the root bridge of MSTI2 and the backup root bridge of MSTI1 in the domain. Please refer to 5 for instructions.
 - The tree-shaped network will eliminate loops.

8.5 Statistics

Instructions:

1. Click the "Spanning Tree > Statistics" in the navigation bar, entry port statistics as follows:

Statistics Table

Refresh Rate sec

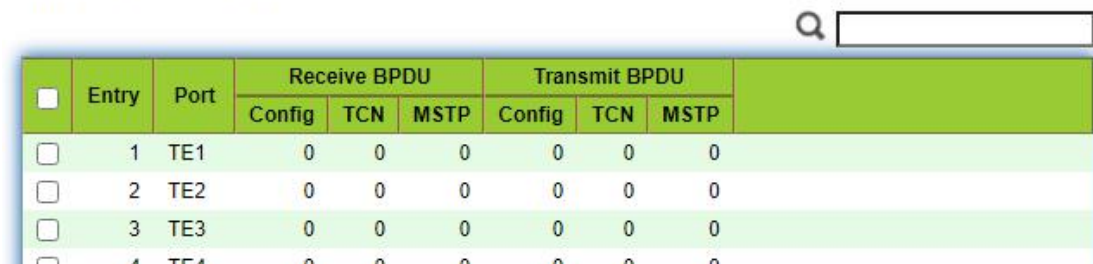

<input type="checkbox"/>	Entry	Port	Receive BPDUs			Transmit BPDUs			
			Config	TCN	MSTP	Config	TCN	MSTP	
<input type="checkbox"/>	1	TE1	0	0	0	0	0	0	
<input type="checkbox"/>	2	TE2	0	0	0	0	0	0	
<input type="checkbox"/>	3	TE3	0	0	0	0	0	0	
<input type="checkbox"/>	4	TE4	0	0	0	0	0	0	

9 ERPS

ERPS (Ethernet Ring Protection Switching) is an Ethernet ring link layer technology with high reliability and stability. It can prevent broadcast storms caused by data loops when the Ethernet ring is complete, and can quickly restore communication paths between various nodes in the ring network in case of link failures in the Ethernet ring, with high convergence speed.

It is based on the ERPS ring and consists of several nodes. By blocking the RPL Owner port and controlling other ordinary ports, the port's state switches between Forwarding and Blocking, achieving the goal of eliminating the loop. Simultaneously utilizing mechanisms such as control VLAN, data VLAN, and MST protection instance to better implement the functionality of ERPS.

9.1 Property

Configure and view the opening and closing of the global ERPS function

Instructions:

1. Click on the "ERPS > Property" menu in the navigation bar to enter the function configuration interface

Erps Status Disable Enable

Apply

9.2 ERPS Instance

In an ERPS network, a ring can support multiple instances, each of which is a logical ring. Each instance has its own protocol channel, data channel, and owner node; Each instance serves as an independent protocol entity, maintaining its own state and data.

Instructions:

1. Click the “ERPS > ERPS Instance” Enter the ERPS instance creation interface and click on the application to create an instance, as shown in the following figure:

Erps Instance (0 - 0)

Apply

ERPS Instance Setting

Instance	Ring Status	Mel	Control Vlan	WTR Time	Guard Time	Work Mode	Ring ID	Ring Type	Protected Instance	Port0	Port Role	Port Status	Port1	Port Role	Port Status	Node Status
<input type="checkbox"/> Ins0	---															

Edit Delete

2. Select the instance and click the modify button to enter the instance configuration interface, as shown in the following figure:

Ring Instance Config

Ins	0
Ring Status	<input checked="" type="radio"/> Disable <input type="radio"/> Enable
Mel	0 (Valid range is 0-7)
Protected Instance	0 (Valid range is 0-15)
Control Vlan	0 (Valid range is 1-4094)
WTR Time	5 (Valid range is 1-12 Min Default is 5 Min)
Guard Time	500 (Valid range is 100-2000 ms. Default is 500 ms)
Work Mode	<input checked="" type="radio"/> Revertive <input type="radio"/> Non_revertive
Ring ID	1 (Valid range is 1-239)
Ring Type	0 (0-master ring)
Port0	N/A
Port0 Role	<input checked="" type="radio"/> Normal <input type="radio"/> owner <input type="radio"/> neighbour <input type="radio"/> next-neighbour
Port1	N/A
Port1 Role	<input checked="" type="radio"/> Normal <input type="radio"/> owner <input type="radio"/> neighbour <input type="radio"/> next-neighbour

Apply Close

Configuration Items	Description
Ring Status	Disable or Enable
Mel	Message level selection 0-7
Protected Instance	The VLAN that transmits ERPS protocol packets and data packets must be mapped to the protection instance, so that the ERPS protocol can forward or block these packets according to its blocking principle. Otherwise, VLAN packets may generate a broadcast storm in the looped network, resulting in network unavailability
Control VLAN	Control VLAN for transmitting ERPS protocol packets
WTR Time	In revertive mode, the RPL Owner port is released due to other link failures. When the fault recovers, wait for the WTR timer to time out and then block the RPL Owner port again
Guard Time	Start the Guard timer when the port detects link recovery, to prevent unnecessary network oscillation caused by residual

	R-APS messages caused by forwarding delay on the ring network
Work Mode	After the ERPS link returns to normal, it can be determined whether to re block the RPL owner port by setting the Revertive/Non Revertive mode of ERPS.
Ring ID	ERPS ring number
Ring Type	0 is the main ring, only support main ring
Port0	ERPS ring member port, used for the transmission of protocol and data packets on the ERPS ring
Port1	ERPS ring member port, used for the transmission of protocol and data packets on the ERPS ring
Port Role	Normal、 Owner、 neighbour、 next-neighbour



Note:

- The ERPS function only satisfies a switching recovery delay of less than 20ms for the optical port
- Only support main ring.

10 Loopback

The configuration of the Loopback Detection function is as follows: global and port ring network enable and disable configurations are performed on the switch ports, which can be changed by the user

The time interval for ring network detection and the automatic recovery time period for ring network ports. By enabling global and port capabilities, the system can detect loop conditions in the network, thereby reducing the occurrence of loop storms. Supports two working modes: automatic detection and manual detection.

1. Click on the "Loopback > Loopback Config" menu in the navigation bar to enter the function

State	<input type="checkbox"/> Enable
All Control Vlan	<input checked="" type="checkbox"/> Enable
resume check	<input type="checkbox"/> Enable
Detection Time	<input type="text" value="5"/> (1 - 32767, default 5)
Resume Time	<input type="text" value="30"/> (10 - 65535, default 30)

loopback port setting table

<input type="checkbox"/>	Entry	Port	Mode	State	Port State
<input type="checkbox"/>	1	TE1	Automation	Disabled	Forwarding
<input type="checkbox"/>	2	TE2	Automation	Disabled	Forwarding
<input type="checkbox"/>	3	TE3	Automation	Disabled	Forwarding
<input type="checkbox"/>	4	TE4	Automation	Disabled	Forwarding

Configuration Items	Description
State	Loopback detection global switch, enable/disable
All Control Vlan	All VLANs on the port are enabled by default
resume check	Loopback recovery detection
Detection Time	Loopback detection cycle, default to 5 seconds
Resume Time	The cycle for automatic detection and recovery time of the loopback, default to 30 seconds
Port	Port list
Mode	Loopback detection working mode, automatic and manual, default to automatic
State	Port level loopback detection switch
Port State	The status of the port

11 Discovery

LLDP (Link Layer Discovery Protocol) is defined in IEEE 802.1ab. It is a standard L2 discovery method which integrates the info such as management addresses, device and interface identifications of local network devices and transmits to the neighbor devices. After receiving the info, they will save it in form of standard MIB (Management Information Base) for NMS query and link communication judgment.

It can also integrate the info and transmit to its own remote devices. The info received by the local network device will be kept in the form of MIB. The following shows how it works.

Block diagram of LLDP principles

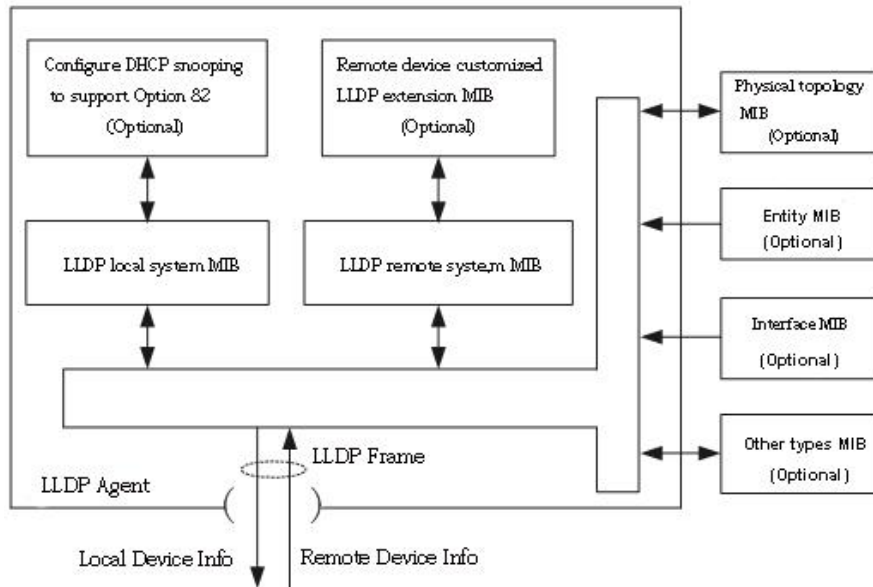

LLDP is realized based on:

- LLDP module updates its local system MIB, as well as the customized extension MIB, through the interaction between LLDP agent and MIBs of physical topology, entity, interface and other types.
- Encapsulate the info of local network device into LLDP frames and transmit to the remote device.
- Receive the LLDP frame sent by the remote device to update LLDP remote system MIB and customized extension MIB.
- Master the info of remote device such as connection interface and MAC address through the transmitting & receiving function of LLDP agent.
- The local system MIB stores local device info, including device and interface IDs, system name and description, interface description, network management address, etc.
- The remote system MIB stores local device info, including device and interface IDs, system name and description, interface description, network management address, etc.

Based on **LLDP**, **LLDP-MED** allows other units to expand. The info checked by network devices facilitates fault analysis and deepens the accurate understanding of network topology by management system.

11.1 LLDP

Instructions:

1. Click the “Discovery > LLDP > Property” in the navigation bar as follows.

LLDP	
State	<input checked="" type="checkbox"/> Enable
LLDP Handling	<input type="radio"/> Filtering <input type="radio"/> Bridging <input checked="" type="radio"/> Flooding
TLV Advertise Interval	30 Sec (5 - 32767, default 30)
Hold Multiplier	4 (2 - 10, default 4)
Reinitializing Delay	2 Sec (1 - 10, default 2)
Transmit Delay	2 Sec (1 - 8191, default 2)
LLDP-MED	
Fast Start Repeat Count	3 (1 - 10, default 3)

Apply

Interface data are as follows.

Configuration Items	Description
State	Enable or disable the LLDP
LLDP Handling	LLDP messages will be processed by means of "Filtering", "Bridging" and "Flooding" when disabling the LLDP.
TLV Advertise Interval	30s by default ranging from 5 to 32,768s.
Hold Multiplier	Transmission period product with 4 by default ranges from 2 to 10. Transmission period * product should be no more than 65,535.
Reinitializing Delay	2s by default ranging from:1 to 10s.
Transmit Delay	2s by default ranging from:1 to 8,191s.
Fast Start Repeat Count	3s by default of the LLDP-MED port ranging from 1 to 10s.

Ethernet message encapsulated with LLDPDU (LLDP Data Unit) are recognized as LLDP message. Each TLV is a unit of LLDPDU carried with specified info.

2. Fill in corresponding configuration items
3. "Apply" and finish.

11.2 Port Setting

Instructions

1. Click the "Discovery > LLDP > Port Setting" in the navigation bar as follows.

Port Setting Table

<input type="checkbox"/>	Entry	Port	Mode	Selected TLV
<input type="checkbox"/>	1	TE1	Normal	802.1 PVID
<input type="checkbox"/>	2	TE2	Normal	802.1 PVID
<input type="checkbox"/>	3	TE3	Normal	802.1 PVID
<input type="checkbox"/>	4	TE4	Normal	802.1 PVID

Interface data are as follows.

Configuration Items	Description
Port	Port list
Mode	LLDP mode include: Transmit, Receive, Normal, Disable, the default is Normal Transmit: transmit LLDP messages only; Receive: receive LLDP messages only; Normal: transmit and receive LLDP messages; Disable: neither transmit nor receive LLDP messages.
Selected TLV	Info of selected TLV and VLAN

LLDP can work in 4 patterns: Transmit: transmit LLDP messages only; Receive: receive LLDP messages only; Normal: transmit and receive LLDP messages; Disable: neither transmit nor receive LLDP messages.

2. Check corresponding port and "Edit" the port configuration. "Apply" and finish as follows.

Edit Port Setting

The screenshot shows the 'Edit Port Setting' dialog box. It has a light yellow background and a blue border. On the left, there are four green dashed boxes with labels: 'Port', 'Mode', 'Optional TLV', and '802.1 VLAN Name'. The 'Port' field is 'TE1'. The 'Mode' section has four radio buttons: 'Transmit', 'Receive', 'Normal' (selected), and 'Disable'. The 'Optional TLV' section has two lists: 'Available TLV' (Port Description, System Name, System Description, System Capabilities, 802.3 MAC-PHY) and 'Selected TLV' (802.1 PVID). The '802.1 VLAN Name' section has two lists: 'Available VLAN' (VLAN 1) and 'Selected VLAN' (empty). At the bottom, there are 'Apply' and 'Close' buttons.

Interface data are as follows.

Configuration Items	Description
Port	Port list
Mode	LLDP mode include: Transmit, Receive, Normal, Disable, the default is Normal Transmit: transmit LLDP messages only; Receive: receive LLDP messages only; Normal: transmit and receive LLDP messages; Disable: neither transmit nor receive LLDP messages.
Optional TLV	Select the info of TLV and VLAN
802.1 VLAN Name	Select the VLAN name

11.3 MED Network Policy

MED is based on IEEE 802.1ab. LLDP is the neighbor discovery protocol of IEEE, which can be extended by other organizations. Information identified from network devices, such as switches and wireless access points, can help with fault analysis and allow management systems to accurately understand the network topology.

Instructions

1. Click the "Discovery > LLDP > MED Network Policy" in the navigation bar as follows.

MED Network Policy Table

Showing All entries Showing 0 to 0 of 0 entries

Policy ID	Application	VLAN	VLAN Tag	Priority	DSCP
0 results found.					

Add MED Network Policy

Policy ID	<input type="text" value="1"/>
Application	<input type="text" value="Voice"/>
VLAN	<input type="text"/> Range (0 - 4095)
VLAN Tag	<input checked="" type="radio"/> Tagged <input type="radio"/> Untagged
Priority	<input type="text" value="0"/>
DSCP	<input type="text" value="0"/>

Interface data are as follows.

Configuration Items	Description
Policy ID	Policy ID number
Application	Configure and publish network policy TLV
VLAN	VLAN number
VLAN Tag	VLAN Mode, optional Tagged or Untagged
Priority	CoS for services
DSCP	DSCP for services

11.4 MED Port Setting

Instructions

1. Click the "Discovery > LLDP > MED Port Setting" in the navigation bar as follows.

MED Port Setting Table

Q

□	Entry	Port	State	Network Policy		Location	Inventory
				Active	Application		
<input type="checkbox"/>	1	TE1	Enabled	Yes		No	No
<input type="checkbox"/>	2	TE2	Enabled	Yes		No	No
<input type="checkbox"/>	3	TE3	Enabled	Yes		No	No
<input type="checkbox"/>	4	TE4	Enabled	Yes		No	No

Edit MED Port Setting

Port	TE1-TE2						
State	<input checked="" type="checkbox"/> Enable						
Optional TLV	<table style="width: 100%; border-collapse: collapse;"> <tr> <td style="width: 50%; padding: 5px;">Available TLV</td> <td style="width: 10%; text-align: center; padding: 5px;">></td> <td style="width: 40%; padding: 5px;">Selected TLV</td> </tr> <tr> <td style="padding: 5px;"> <div style="border: 1px solid #ccc; padding: 2px;">Location</div> <div style="border: 1px solid #ccc; padding: 2px;">Inventory</div> </td> <td style="text-align: center; padding: 5px;"><</td> <td style="padding: 5px;"> <div style="border: 1px solid #ccc; padding: 2px;">Network Policy</div> </td> </tr> </table>	Available TLV	>	Selected TLV	<div style="border: 1px solid #ccc; padding: 2px;">Location</div> <div style="border: 1px solid #ccc; padding: 2px;">Inventory</div>	<	<div style="border: 1px solid #ccc; padding: 2px;">Network Policy</div>
Available TLV	>	Selected TLV					
<div style="border: 1px solid #ccc; padding: 2px;">Location</div> <div style="border: 1px solid #ccc; padding: 2px;">Inventory</div>	<	<div style="border: 1px solid #ccc; padding: 2px;">Network Policy</div>					
Network policy	<table style="width: 100%; border-collapse: collapse;"> <tr> <td style="width: 50%; padding: 5px;">Available Policy</td> <td style="width: 10%; text-align: center; padding: 5px;">></td> <td style="width: 40%; padding: 5px;">Selected Policy</td> </tr> <tr> <td style="padding: 5px;"> <div style="border: 1px solid #ccc; height: 20px;"></div> </td> <td style="text-align: center; padding: 5px;"><</td> <td style="padding: 5px;"> <div style="border: 1px solid #ccc; height: 20px;"></div> </td> </tr> </table>	Available Policy	>	Selected Policy	<div style="border: 1px solid #ccc; height: 20px;"></div>	<	<div style="border: 1px solid #ccc; height: 20px;"></div>
Available Policy	>	Selected Policy					
<div style="border: 1px solid #ccc; height: 20px;"></div>	<	<div style="border: 1px solid #ccc; height: 20px;"></div>					
Location							
Coordinate	<input style="width: 90%;" type="text"/> (16 pairs of hexadecimal characters)						
Civic	<input style="width: 90%;" type="text"/> (6 - 160 pairs of hexadecimal characters)						
ECS ELIN	<input style="width: 90%;" type="text"/> (10 - 25 pairs of hexadecimal characters)						

Apply
Close

Interface data are as follows.

Configuration Items	Description
Entry	Serial No. of MED port setting
Port	Port list
State	Port enable status
Network Policy	Configure and publish network policy TLV
Location	Configure and publish location TLV
Inventory	Configure and publish inventory TLV

11.5 Packet View

Instructions

1. Click the “Discovery > LLDP > Packet View” in the navigation bar as follows.

Packet View Table

Q

Entry	Port	In-Use (Bytes)	Available (Bytes)	Operational Status
<input type="radio"/>	1 TE1	38	1450	Not Overloading
<input type="radio"/>	2 TE2	38	1450	Not Overloading
<input type="radio"/>	3 TE3	38	1450	Not Overloading
<input type="radio"/>	4 TE4	38	1450	Not Overloading

11.6 Local Information

Instructions for device summary:

1. Click the “Discovery > LLDP > Local Information” in the navigation bar as follows.

Device Summary

Chassis ID Subtype	MAC address
Chassis ID	1C:2A:A3:00:00:24
System Name	Switch
System Description	ZX510S-4T2XS
Supported Capabilities	Bridge, Router
Enabled Capabilities	Bridge, Router
Port ID Subtype	Local

Instructions for port status table:

2. Click the “Discovery > LLDP > Local Information” in the navigation bar as follows.

Port Status Table

Q

Entry	Port	LLDP State	LLDP-MED State
<input type="radio"/>	1 TE1	Normal	Enabled
<input type="radio"/>	2 TE2	Normal	Enabled
<input type="radio"/>	3 TE3	Normal	Enabled
<input type="radio"/>	4 TE4	Normal	Enabled

11.7 Neighbor

Instructions for LLDP neighbor displaying

1. Click the “Discovery > LLDP > Neighbor” in the navigation bar as follows.

Neighbor Table

Showing All entries Showing 1 to 3 of 3 entries

<input type="checkbox"/>	Local Port	Chassis ID Subtype	Chassis ID	Port ID Subtype	Port ID	System Name	Time to Live
<input type="checkbox"/>	TE1	MAC address	1C:2A:A3:00:00:63	Local	GE30		91
<input type="checkbox"/>	TE2	MAC address	1C:2A:A3:00:00:63	Local	TE2		95
<input type="checkbox"/>	TE4	MAC address	1C:2A:A3:48:00:00	Local	GE1		90

11.8 Statistics

Instructions:

1. Click the “Discovery > LLDP > Statistics” in the navigation bar as follows.

Global Statistics

Insertions	1
Deletions	0
Drops	0
AgeOuts	0

Statistics Table

<input type="checkbox"/>	Entry	Port	Transmit Frame	Receive Frame			Receive TLV		Neighbor
			Total	Total	Discard	Error	Discard	Unrecognized	Timeout
<input type="checkbox"/>	1	TE1	0	0	0	0	0	0	0
<input type="checkbox"/>	2	TE2	0	0	0	0	0	0	0
<input type="checkbox"/>	3	TE3	0	0	0	0	0	0	0

12 Multicast

12.1 General

12.1.1 Property

Instructions:

1. Click the “Multicast > General > Property” in the navigation bar as follows.

Unknown Multicast Action	<input checked="" type="radio"/> Flood
	<input type="radio"/> Drop
	<input type="radio"/> Forward to Router Port
Multicast Forward Method	
IPv4	<input checked="" type="radio"/> DMAC-VID
	<input type="radio"/> DIP-VID
IPv6	<input checked="" type="radio"/> DMAC-VID
	<input type="radio"/> DIP-VID
<input type="button" value="Apply"/>	

12.1.2 Group Address

According to the previous request mode of multicast, the multicast router will copy and forward data to each VLAN containing receivers when users in different VLANs request the same multicast group, which wastes a great deal of bandwidth. IGMP Snooping configures multicast VLAN by connecting the different users of switch ports to a same multicast VLAN to receive multicast data. In this way, multicast flow can only be transmitted within a multicast VLAN, thus saving bandwidth. In addition, security and bandwidth are guaranteed because multicast VLANs are completely isolated from user VLANs.

Instructions

1. Click the “Multicast > Group Address”, “Add” a new static multicast item, and “Edit” the existing ones as follows:

Group Address Table

Showing entries Showing 0 to 0 of 0 entries

<input type="checkbox"/>	VLAN	Group Address	Member	Type	Life (Sec)
0 results found.					

Interface data are as follows.

Configuration Items	Description
VLAN	VLAN ID to which the multicast group belongs. Drop down to select an existing VLAN.
Multicast Address	Enter the multicast address
Member	Add multicast member(s)

2. Fill in corresponding configuration items.
3. "Apply" and finish as follows.

Group Address Table

Showing entries Showing 1 to 1 of 1 entries

<input type="checkbox"/>	VLAN	Group Address	Member	Type	Life (Sec)
<input type="checkbox"/>	1	224.1.1.111	TE1	Static	

12.1.3 Router Port

Configure and view multicast router port

Instructions:

1. Click the "Multicast > General > Router Port" in the navigation bar as follows.

Router Port Table

Showing entries Showing 0 to 0 of 0 entries

<input type="checkbox"/>	VLAN	Member	Static Port	Forbidden Port	Life (Sec)
0 results found.					

12.2 IGMP Snooping

IGMP Snooping (Internet Group Management Protocol Snooping) is a constraint mechanism on L2 devices to manage and control multicast groups. By analyzing the IGMP messages received, L2 devices establish a mapping between ports and MAC multicast addresses and forward the multicast data accordingly. As shown below, multicast data are transmitted on L2 without IGMP snooping. When IGMP snooping runs, known multicast group data are transmitted to specified receivers while unknown multicast data are still on Layer 2.

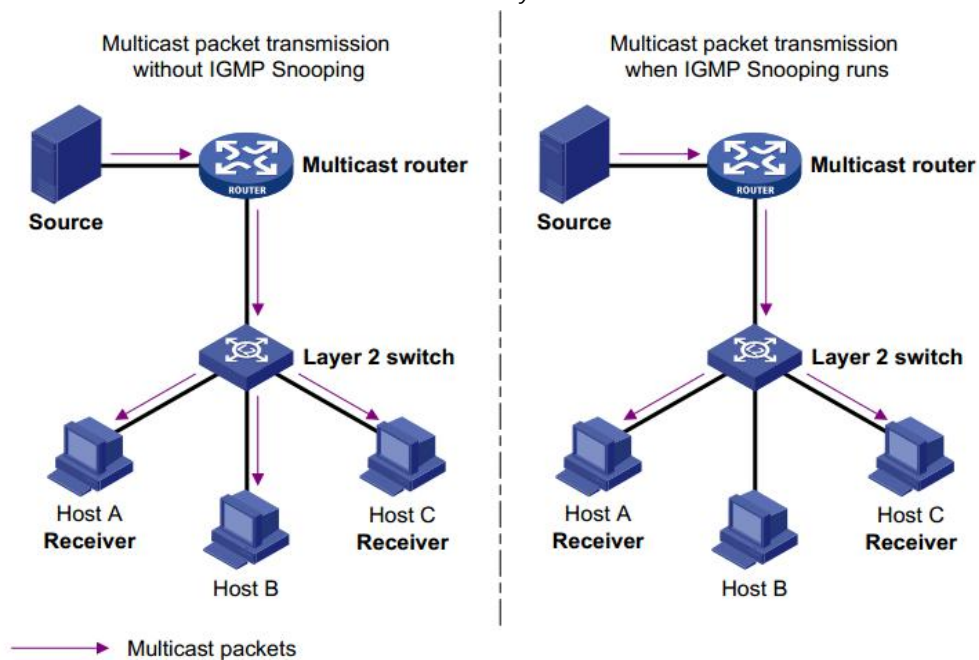

12.2.1 Property

IGMP Snooping is on the L2 switch between the multicast routers and the user hosts, applicable to deploy IPv4 networks. It is configured in a VLAN to snoop the IGMP/MLD messages transmitted between routers and hosts, and to establish a L2 forwarding table for multicast data, in order to manage and control the multicast data forwarding in L2 network.

Global IGMP Snooping function should be enabled since it is disabled by default.

Instructions:

1. Click the "Multicast > IGMP Snooping > Property", select the VLAN to be configured from the created VLAN info, and "Edit" the details as follows:

State	<input type="checkbox"/> Enable
Version	<input checked="" type="radio"/> IGMPv2 <input type="radio"/> IGMPv3
Report Suppression	<input checked="" type="checkbox"/> Enable

Apply

VLAN Setting Table

VLAN	Operational Status	Router Port Auto Learn	Query Robustness	Query Interval	Query Max Response Interval	Last Member Query Counter	Last Member Query Interval	Immediate Leave
1	Disabled	Enabled	2	125	10	2	1	Disabled

Edit

Interface data are as follows.

Configuration Items	Description
VLAN	VLAN ID to be configured
State	Enable or disable the IGMP Snooping in this VLAN
Router Port Auto Learn	Enable or disable route port automatic learning
Immediate leave	Multicast members leave quickly
Query Robustness	The Robustness Variable allows tuning for the expected packet loss on a network
Query Interval	The interval between message queries
Query Max Response Interval	Timeout (over the max response time) of a query message
Last Member Query Counter	Max number of queries for a specified group
Last Member Query Interval	The interval between message queries for a specified group

- Fill in corresponding configuration items.
- “Apply” and finish.

13 Security

13.1 Management Access

13.1.1 Management Service

Instructions for Telnet:

1. Click the “Security > Management Access > Management Service”, enter management service interface as follows:



The screenshot shows the 'Management Service' configuration page. It has a green header bar with the title 'Management Service'. Below the header, there are two rows of settings. The first row is for 'HTTP', with a checked checkbox and the text 'Enable'. The second row is for 'SNMP', with an unchecked checkbox and the text 'Enable'. Below these is another green header bar for 'Session Timeout'. Underneath, there is a row for 'HTTP' with a text input field containing the value '10' and a label 'Min (0 - 65535, default 10)'. At the bottom of the form is a blue 'Apply' button.

Instructions for SNMP:

2. Click the “Security > Management Access > Management Service”, enter management service interface as follows:



The screenshot shows the 'Management Service' configuration page, similar to the previous one. The 'HTTP' checkbox is checked and labeled 'Enable'. The 'SNMP' checkbox is also checked and labeled 'Enable'. The 'Session Timeout' section for 'HTTP' shows a text input field with '10' and the label 'Min (0 - 65535, default 10)'. A blue 'Apply' button is at the bottom.

13.2 DHCP Snooping

For sake of security, the network administrator may need to record the IP address of a user surfing the Internet and to confirm the correspondence between the IP address obtained from DHCP Server and the host's MAC address.

Switch can record the user's IP address through the secure DHCP relay at the network layer.

Switch can monitor DHCP messages and record the user's IP address through DHCP Snooping at the data link layer. In addition, private DHCP Server in the network may lead to wrong IP address for the user. To ensure that users obtain IP addresses through legal DHCP Server, the DHCP Snooping security mechanism divides the ports into Trust Port and Untrust Port.

Trust Port directly or indirectly connects legal DHCP Server. It forwards the DHCP messages received to ensure the correct IP address for DHCP Client. Untrust Port connects illegal DHCP Server. DHCPACK and DHCPOFFER messages received from the DHCP Server on the Untrust Port will be discarded to prevent incorrect IP addresses.

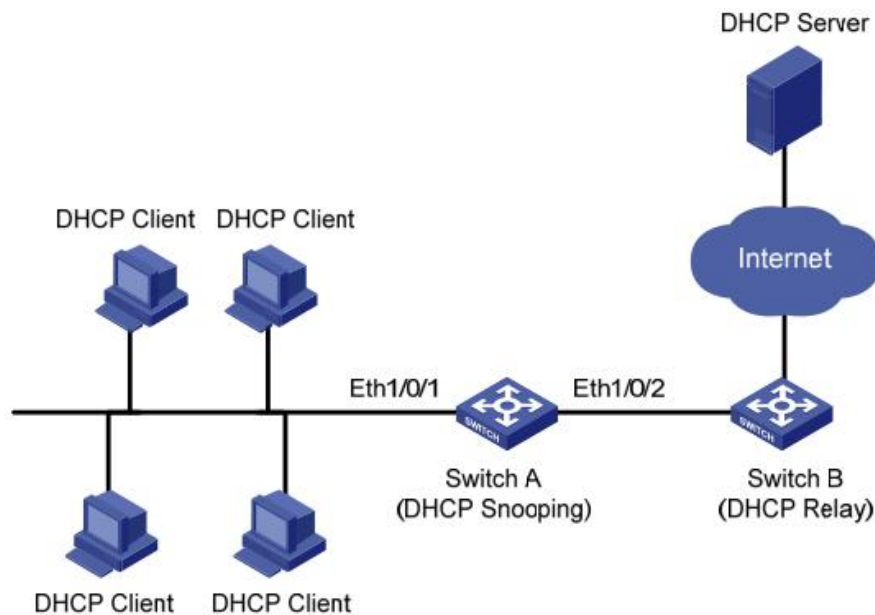

Typical Networking of DHCP Snooping

The following methods are used to obtain the IP address and user MAC address from DHCP Server:

- Snooping the DHCPREQUEST message
- Snooping the DHCPACK message

13.2.1 Property

Enable DHCP Snooping

Instructions:

1. Click the "Security > DHCP Snooping > Property". DHCP Snooping interface is divided into global configuration and port configuration. Select the port to be modified in the port configuration and "Edit" the details as follows:

Enable

Available VLAN

VLAN 1
 VLAN 10
 VLAN 100

Selected VLAN

Port Setting Table

Q

<input type="checkbox"/>	Entry	Port	Trust	Verify Chaddr	Rate Limit
<input type="checkbox"/>	1	TE1	Disabled	Disabled	Unlimited
<input type="checkbox"/>	2	TE2	Disabled	Disabled	Unlimited
<input type="checkbox"/>	3	TE3	Disabled	Disabled	Unlimited
<input type="checkbox"/>	4	TE4	Disabled	Disabled	Unlimited

Interface data are as follows.

Configuration Items	Description
State	Enable and disable the DHCP Snooping
VLAN	Valid VLAN No. of DHCP Snooping
Port	Configure the port No. of DHCP Snooping
Trust	Whether the port is a Trust Port
Client Address Inspection	Whether the consistency inspection for Client addresses is enabled
Rate Limit	Whether the port enables rate limit and configures the value

- Fill in corresponding configuration items.
- “Apply” and finish as follows.

13.2.2 IMPV Binding

Used to query the binding table entries for DHCP Snooping.

Instructions:

- Click the “Security > DHCP Snooping > IMPV Binding”, as follows:

IP-MAC-Port-VLAN Binding Table

Showing entries Showing 0 to 0 of 0 entries

<input type="checkbox"/>	Port	VLAN	MAC Address	IP Address	Binding	Type	Lease Time
0 results found.							

Interface data are as follows.

Configuration Items	Description
Port	The port No. of binding group
VLAN	VLAN ID bound
Binding	Select the binding relation from IPMV and IPV
MAC Address	MAC address bound
IP Address	IP address bound

2. Fill in corresponding configuration items.
3. "Apply" and finish as follows.

14 QoS

QoS (Quality of Service) assesses the ability of service providers to meet customer needs and the ability of transmitting packets over the Internet. Diversified services can be assessed based on different aspects. QoS usually refers to the evaluation of service capabilities that support core requirements such as bandwidth, delay, delay variation, and packet loss rate during delivery. Bandwidth, also known as throughput, refers to the average business flow within a certain period of time, with the unit of Kbit/s. Delay refers to the average time required for business flowing through the network. For a network device, the followings are general levels of delay requirements. There are two delay levels, that is, the high-priority business can be served as soon as possible by scheduling method of priority queue, while the low-priority business gets services after that. Delay variation refers to the time change of business flowing through the network. Packet loss rate refers to the percentage of lost business flow during transmission. As modern transmission systems are very reliable, information is often lost in network congestion. Packet loss due to queue overflow is the most common situation.

All messages in a traditional IP network are treated equally. Every network device processes the messages on a FIFO basis, and makes every effort to transmit them to destinations without guaranteeing reliability, transfer delay, or other performance.

Network service quality is constantly improved as new applications keep springing up in the rapidly changing IP network. For example, VoIP, video and other delay-sensitive services have set higher standards on message transmission delay. Message transmission in a short period has been the common trend. In order to support voice, video and data services with different requirements, the network needs to identify business types and provide corresponding services.

The ability to distinguish business types is the prerequisite to provide corresponding services, so the traditional best-effort service no longer meets the application needs. Therefore, QoS comes into being. It regulates the network flow to avoid and handle network congestion and reduce packet loss rate. Meanwhile, users can enjoy dedicated bandwidths while business can improve service quality, thus perfecting the network service capacity.

QoS priorities vary with message types. For instance, the VLAN message uses 802.1p, also known as the CoS (Class of Service) field, while the IP message uses DSCP. To maintain the priority, these fields need to be mapped at the gateway connected with various networks when messages flow through the network.

802.1p priority in the VLAN frame header

Typically, VLAN frames are interacted between Layer 2 devices. The PRI field (i.e. 802.1p priority), or CoS field, in the VLAN frame header identifies the quality of service requirements according to the definitions in IEEE 802.1Q.

802.1p priority in the VLAN frame

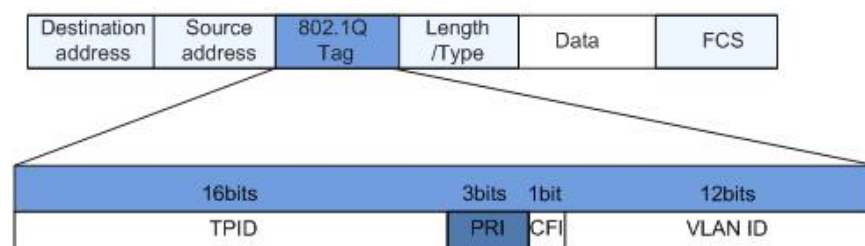

The 802.1Q header contains 3-bit PRI fields. PRI field defines 8 CoS of business priority ranging from 7 to 0 from high to low.

IP Precedence/DSCP Field

According to RFC791 definition, ToS (Type of Service) domain in the IP message header is composed of 8 bits. Among them, the 3-bit long Precedence field, as located in the following, identifies the IP message priority.

IP Precedence/DSCP Field

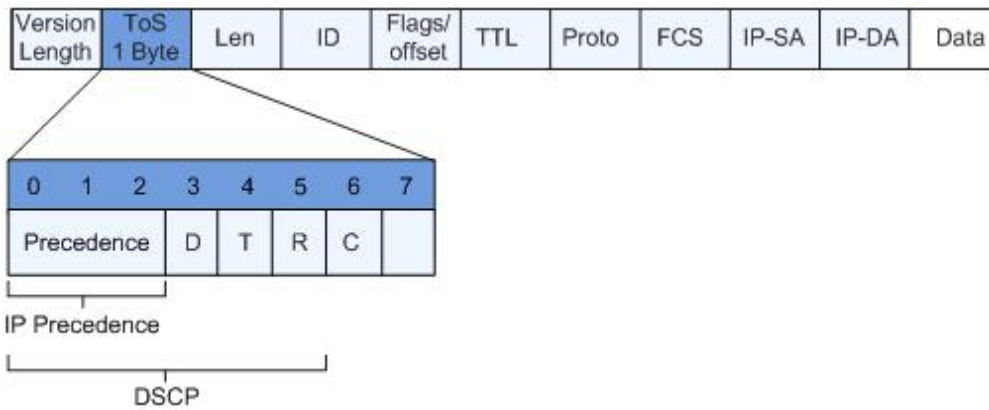

0 to 2 bits are Precedence fields representing the 8 priorities of message transmission ranging from 7 to 0 from high to low, with either Level 7 or 6 as the highest priority that is generally reserved for routing or updating network control communication. User-level applications only have access to Level 0 to 5.

ToS domain, in addition to Precedence fields, also includes D, T and R bits: D-bit represents the Delay requirement (0 for normal delay and 1 for low delay). T-bit represents the throughput (0 for normal throughput and 1 for high throughput). R-bit represents the reliability (0 for normal reliability and 1 for high reliability). ToS domain reserves the 6 and 7 bits.

RFC1349 redefines the ToS domain by adding a C-bit to represent the Monetary Cost. The IETF DiffServ group then redefines the 0 to 5 bits of ToS domain in the IPv4 message header of RFC2474 as DSCP and renames it as DS (Differentiated Service) byte as shown in the figure above.

The first 6 bits (0-5 bits) of DS field distinguish the DSCP (DS Code Point), and the higher 2 bits (6-7 bits) are reserved. The lower 3 bits (0-2 bits) are CSCP (Class Selector Code Point), with the same CSCP value representing the DSCP of the same class. DS nodes select corresponding PHB (Per-Hop Behavior) according to DSCP values.

14.1 General

14.1.1 Property

Network congestion resulting from the competition for resource use rights among messages at the same time is usually solved by queue scheduling, thus avoiding intermittent congestions. Queue scheduling technologies include SP (Strict-Priority), WRR (Weighted Round Robin).

Instructions for global and port scheduling configuration

1. Click the "QoS > General > Property" in the navigation bar as follows.

State	<input type="checkbox"/> Enable
Trust Mode	<input checked="" type="radio"/> CoS <input type="radio"/> DSCP <input type="radio"/> CoS-DSCP

Port Setting Table

<input type="checkbox"/>	Entry	Port	CoS	Trust	Remarking	
					CoS	DSCP
<input type="checkbox"/>	1	TE1	0	Enabled	Disabled	Disabled
<input type="checkbox"/>	2	TE2	0	Enabled	Disabled	Disabled
<input type="checkbox"/>	3	TE3	0	Enabled	Disabled	Disabled
<input type="checkbox"/>	4	TE4	0	Enabled	Disabled	Disabled

Interface data of global configuration are as follows.

Configuration Items	Description
State	Switch of global QoS function
Trust Mode	It can be divided into CoS, DSCP, CoS-DSCP

Interface data of port configuration are as follows.

Configuration Items	Description
CoS	Ranging from 0 to 7
Port Trust Mode	Switch of port QoS function
CoS	Mark the CoS field
DSCP	Mark the DSCP field

14.1.2 Queue Scheduling

1. Click the "QoS > General > Queue Scheduling". "Apply" and finish as follows.

Queue Scheduling Table

Queue	Method			
	Strict Priority	WRR	Weight	
1	<input checked="" type="radio"/>	<input type="radio"/>	1	
2	<input checked="" type="radio"/>	<input type="radio"/>	2	
3	<input checked="" type="radio"/>	<input type="radio"/>	3	
4	<input checked="" type="radio"/>	<input type="radio"/>	4	
5	<input checked="" type="radio"/>	<input type="radio"/>	5	
6	<input checked="" type="radio"/>	<input type="radio"/>	9	
7	<input checked="" type="radio"/>	<input type="radio"/>	13	
8	<input checked="" type="radio"/>	<input type="radio"/>	15	

Apply

Interface data are as follows.

Configuration Items	Description
Strict Priority	SP mode
WRR	WRR mode
Weight	Bandwidth percentage of WRR accounted for by Queue

14.1.3 CoS Mapping

1. Click the "QoS > General > CoS Mapping" in the navigation bar. "Apply" and finish as follows.

CoS to Queue Mapping

CoS	Queue	
0	1 ▼	
1	2 ▼	
2	3 ▼	
3	4 ▼	
4	5 ▼	
5	6 ▼	
6	7 ▼	
7	8 ▼	

Apply

Queue to CoS Mapping

Queue	CoS	
1	0 ▼	
2	1 ▼	
3	2 ▼	
4	3 ▼	
5	4 ▼	
6	5 ▼	
7	6 ▼	
8	7 ▼	

Apply

Interface data are as follows.

Configuration Items	Description
CoS	802.1p priority
Queue	Port queue

14.1.4 DSCP Mapping

1. Click the "QoS > General > DSCP Mapping". "Apply" and finish as follows.

DSCP to Queue Mapping

DSCP	Queue	DSCP	Queue	DSCP	Queue	DSCP	Queue
0 [CS0]	1 ▼	16 [CS2]	3 ▼	32 [CS4]	5 ▼	48 [CS6]	7 ▼
1	1 ▼	17	3 ▼	33	5 ▼	49	7 ▼
2	1 ▼	18 [AF21]	3 ▼	34 [AF41]	5 ▼	50	7 ▼
3	1 ▼	19	3 ▼	35	5 ▼	51	7 ▼
4	1 ▼	20 [AF22]	3 ▼	36 [AF42]	5 ▼	52	7 ▼
5	1 ▼	21	3 ▼	37	5 ▼	53	7 ▼
6	1 ▼	22 [AF23]	3 ▼	38 [AF43]	5 ▼	54	7 ▼
7	1 ▼	23	3 ▼	39	5 ▼	55	7 ▼
8 [CS1]	2 ▼	24 [CS3]	4 ▼	40 [CS5]	6 ▼	56 [CS7]	8 ▼
9	2 ▼	25	4 ▼	41	6 ▼	57	8 ▼
10 [AF11]	2 ▼	26 [AF31]	4 ▼	42	6 ▼	58	8 ▼
11	2 ▼	27	4 ▼	43	6 ▼	59	8 ▼
12 [AF12]	2 ▼	28 [AF32]	4 ▼	44	6 ▼	60	8 ▼
13	2 ▼	29	4 ▼	45	6 ▼	61	8 ▼
14 [AF13]	2 ▼	30 [AF33]	4 ▼	46 [EF]	6 ▼	62	8 ▼
15	2 ▼	31	4 ▼	47	6 ▼	63	8 ▼

Apply

Queue to DSCP Mapping

Queue	DSCP
1	0 [CS0] ▼
2	8 [CS1] ▼
3	16 [CS2] ▼
4	24 [CS3] ▼
5	32 [CS4] ▼
6	40 [CS5] ▼
7	48 [CS6] ▼
8	56 [CS7] ▼

Apply

Interface data are as follows.

Configuration Items	Description
DSCP	Value of IP DHCP domain priority
Queue	Port queue

14.2 Rate limit

14.2.1 Ingress / Egress Port

It refers to the rate restriction on transmitting and receiving data at physical interfaces.

Restrict the rate limiting at the egress before transmitting flow, thus controlling all outgoing message flow;

Restrict the rate limiting at the ingress before receiving flow, thus controlling all incoming message flow;

Instructions:

1. Click the “QoS > Rate Limit > Ingress / Egress Port” in the navigation bar to choose a rate-limiting port and check the current configuration as follows:

Ingress / Egress Port Table

Q

<input type="checkbox"/>	Entry	Port	Ingress		Egress	
			State	Rate (Kbps)	State	Rate (Kbps)
<input type="checkbox"/>	1	TE1	Disabled		Disabled	
<input type="checkbox"/>	2	TE2	Disabled		Disabled	
<input type="checkbox"/>	3	TE3	Disabled		Disabled	
<input type="checkbox"/>	4	TE4	Disabled		Disabled	
<input type="checkbox"/>	5	TE5	Disabled		Disabled	
<input type="checkbox"/>	6	TE6	Disabled		Disabled	
<input type="checkbox"/>	7	TE7	Disabled		Disabled	
<input type="checkbox"/>	8	TE8	Disabled		Disabled	

2. Select the port (s) for rate limiting, “Edit” it at the bottom to switch the function and specify the rate. “Apply” and finish as follows:

Edit Ingress / Egress Port

Port	TE1-TE2
Ingress	<input checked="" type="checkbox"/> Enable <input type="text" value="10000000"/> Kbps (16 - 10000000)
Egress	<input checked="" type="checkbox"/> Enable <input type="text" value="10000000"/> Kbps (16 - 10000000)

Interface data are as follows.

Configuration Items		Description
Ingress	Enabled	Rate limiting switch
	Rate	Rate ranges from 16 to 10,000,000 Kbps
Egress	Enabled	Rate limiting switch
	Rate	Rate ranges from 16 to 10,000,000 Kbps

15 Diagnostics

15.1 Ping

Ping command checks the availability of specified IP addresses and host names and transmits statistics accordingly.

Instructions:

1. Click the “Diagnostics > Ping” in the navigation bar to enter a host name or an IP address, as well as the number of tests as follows:

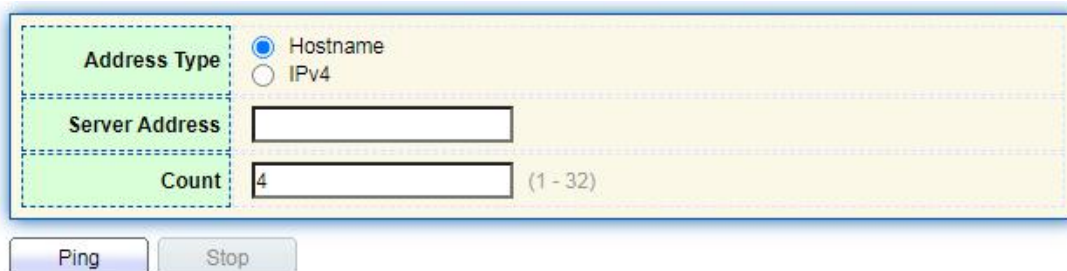

The screenshot shows a web-based configuration interface for a ping test. It features a light yellow background with a dashed border. On the left, there are three green boxes with white text labels: 'Address Type', 'Server Address', and 'Count'. To the right of 'Address Type' are two radio buttons: 'Hostname' (which is selected with a blue dot) and 'IPv4'. To the right of 'Server Address' is an empty text input field. To the right of 'Count' is a text input field containing the number '4', followed by the text '(1 - 32)'. Below the form are two buttons: a blue 'Ping' button and a grey 'Stop' button.

2. Click the “Ping” to accept the packet-transmitting test from system to verify address validity, and output the result as follows:

Ping Result

Packet Status	
Status	Success.
Transmit Packet	4
Receive Packet	4
Packet Lost	0 %

Round Trip Time	
Min	0 ms
Max	0 ms
Average	0 ms

15.2 Copper Test

Copper test evaluates the ingress cable state and locates the faults (about 5 m by error) according to the reflected voltage strength

Instructions:

1. Click the “Diagnostics > Copper Test” in the navigation bar to select a port for test as follows:

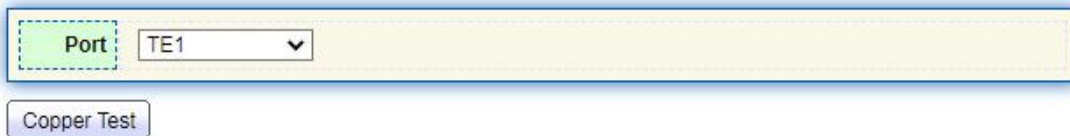

Port: TE1

Copper Test

2. Click the “Copper Test” and output the result as follows:

Copper Test Result

Cable Status	
Port	TE2
Result	OK
Length	N/A

15.3 Fiber Module

Can be used to view optical module DDM information

Instructions:

1. Click the “Diagnostics > Fiber Module” in the navigation bar to select a port for test as

follows:

Fiber Module Table

	Port	Temperature (C)	Voltage (V)	Current (mA)	Output Power (mW)	Input Power (mW)	OE Present	Loss of Signal
<input type="radio"/>	TE5	15.61	3.34	9.59	0.09	1.51	Insert	Normal
<input type="radio"/>	TE6	48.58	3.33	37.56	0.66	0.58	Insert	Normal

16 Management

16.1 User Account

Users can check and modify the current username, password and authority of the switch.

Instructions:

1. Click the “Management > User Account” in the navigation bar to discover the username of “admin” and the privilege of “Admin” by default as follows:

User Account

Showing entries Showing 1 to 1 of 1 entries

<input type="checkbox"/>	Username	Privilege
<input type="checkbox"/>	admin	Admin

2. “Add” a new user account and “Edit” the selected user attribute as follows:

Add User Account

Username	<input type="text"/>
Password	<input type="text"/>
Confirm Password	<input type="text"/>
Privilege	<input checked="" type="radio"/> Admin <input type="radio"/> User

16.2 Firmware

System version firmware upgrade

Instructions:

1. Click the “Management > Firmware > Manual Upgrade” in the navigation bar as follows:



The screenshot shows a configuration form for a firmware upgrade. It has four sections: File Type, Action, Method, and Filename. The File Type section has a radio button for 'Image' which is selected. The Action section has a radio button for 'Upgrade' which is selected. The Method section has two radio buttons: 'TFTP' and 'HTTP', with 'HTTP' selected. The Filename section has a 'Choose File' button and a text box containing 'No file chosen'. Below the form is an 'Apply' button.

16.3 Configuration

16.3.1 Manual Upgrade

System configuration upgrade or backup

Instructions for configuration file upgrade:

1. Click the “Management > Configuration > Manual Upgrade” click the “Upgrade” in mode of “TFTP” or “HTTP”, select the corresponding files to be upgraded (servers should be illustrated in TFTP mode). “Apply” and finish as follows:

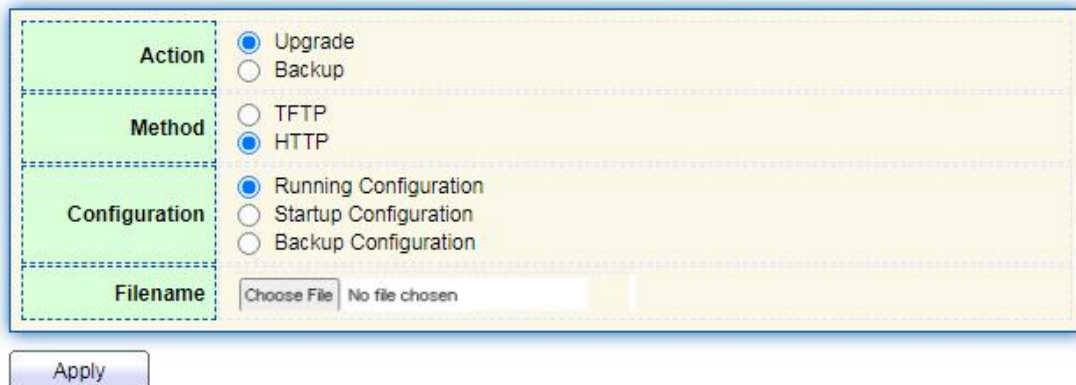

The screenshot shows a configuration form for a configuration file upgrade. It has four sections: Action, Method, Configuration, and Filename. The Action section has two radio buttons: 'Upgrade' and 'Backup', with 'Upgrade' selected. The Method section has two radio buttons: 'TFTP' and 'HTTP', with 'HTTP' selected. The Configuration section has three radio buttons: 'Running Configuration', 'Startup Configuration', and 'Backup Configuration', with 'Running Configuration' selected. The Filename section has a 'Choose File' button and a text box containing 'No file chosen'. Below the form is an 'Apply' button.

Instructions for file backup configuration:

2. click the “Backup” in mode of “TFTP” or “HTTP”, select the files or logs to be upgraded (servers should be illustrated in TFTP mode). “Apply” and finish as follows.

Action	<input type="radio"/> Upgrade <input checked="" type="radio"/> Backup
Method	<input type="radio"/> TFTP <input checked="" type="radio"/> HTTP
Configuration	<input checked="" type="radio"/> Running Configuration <input type="radio"/> Startup Configuration <input type="radio"/> Backup Configuration

Apply

16.3.2 Save Configuration

Save system configuration or restore configuration to factory default

Instructions:

1. Click the "Management > Configuration > Save Configuration" in the navigation bar as follows:

Source File	<input checked="" type="radio"/> Running Configuration <input type="radio"/> Startup Configuration <input type="radio"/> Backup Configuration
Destination File	<input checked="" type="radio"/> Startup Configuration <input type="radio"/> Backup Configuration

Apply Restore Factory Default

 **Note:**

- Click the "Factory Reset" and "Device Restart" to restore factory settings. Save the "Running Configuration" as the "Start Configuration" (which can be saved as "Backup Configuration" or "Running Configuration") and the "Backup Configuration" (which can be saved as the "Start Configuration" or "Running Configuration").

Instructions for the second method of system preservation:

2. Click the "Save" on the upper right to save the running configuration as the start configuration as follows.



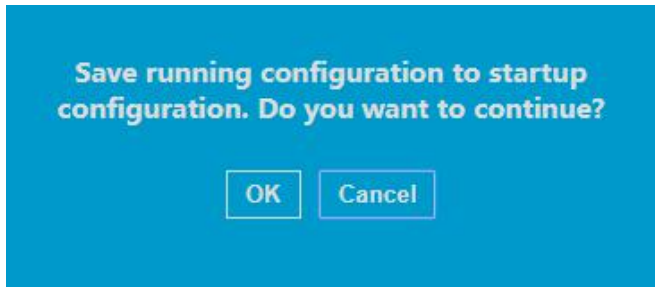

16.4 SNMP

SNMP (Simple Network Management Protocol) is widely used in TCP/IP network. It manages devices by the central computer which operates network management software (i.e. network management workstation). SNMP is:

- Simple: The polling-driving SNMP has the fundamental functionality set that is applicable to small-scale environment with fast speed and low cost. Besides, UDP-driven SNMP is compatible with most devices. Powerful: SNMP aims to ensure the management info transmission between two nodes so that administrators can retrieve, modify and troubleshoot the info easily. There are 3 common versions, namely SNMPv1, v2c and v3. Its system contains NMS (Network Management System), Agent, Management object and MIB (Management Information Base).
- NMS, as the management center, will manage all devices. Each device under management includes the resident Agent, MIB and management objects. NMS interacts with the Agent running on the management object which will operate the MIB to execute NMS orders.

SNMP management model

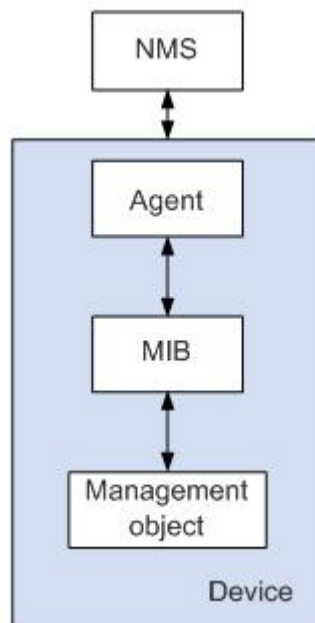

NMS

- As the network administrator, NMS manages/monitors network devices by SNMP on its server. It can request the Agent to inquire or modify specified parameter(s). NMS can receive the Trap actively sent by the Agent to be updated with the states of the managed devices.

Agent

- As an agent process of the managed devices, it maintains device data and responds to the NMS requests by reporting management data. Agent will fulfill relevant orders through MIB Table and transmit the results back to NMS after receiving its request. Devices will take the initiative to transmit info related to the current statuses of devices to NMS through Agent once a fault or another event occurs.

Management object

- It refers to the object under management. Each device may have more than one objects, including a piece of hardware (e.g. an interface board), partial hardware and software (e.g. routing protocol), as well as other configuration item sets

MIB

- MIB is a database specifying the variables maintained by the management object (i.e. the info that can be inquired and set by the Agent). MIB defines the attributes of the management object, including the name, state, access right and data type. The following functions can be realized through MIB: Agent will master the instant device info by inquiring MIB and set the state configuration items by changing MIB.

16.4.1 View

1. Click the “Management > SNMP > View” in the navigation bar as follows.

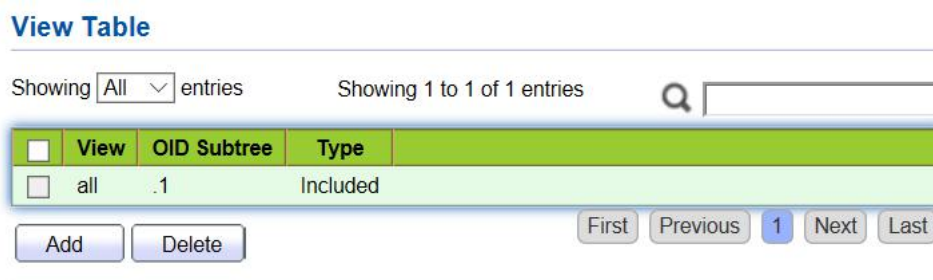

Interface data are as follows.

Configuration Items	Description
View	View name
OID Subtree	View OID

Type	View type: "Included" or "Excluded"
------	-------------------------------------

2. "Add" the corresponding configuration, "Apply" and finish.

Add View

View	
OID Subtree	
Type	<input checked="" type="radio"/> Included <input type="radio"/> Excluded

16.4.2 Group

1. Click the "Management > SNMP > Group" in the navigation bar as follows.

Group Table

Showing All entries Showing 0 to 0 of 0 entries

□	Group	Version	Security Level	View		
				Read	Write	Notify
0 results found.						

Configure [SNMP View](#) to associate a non-default view with a group.

Interface data are as follows.

Configuration Items	Description
Group	Group name
Version	V1, V2, V3
Security Level	Security level
View	Views are divided into view reading, writing and notification.

2. Click the "Add" to fill in corresponding configuration. "Apply" and finish.

Add Group

Group:

Version: SNMPv1, SNMPv2, SNMPv3

Security Level: No Security, Authentication, Authentication and Privacy

View: Read, Write, Notify

all, all, all

Apply Close

16.4.3 Community

1. Click the “Management > SNMP > Community” in the navigation bar as follows.

Community Table

Showing All entries Showing 1 to 1 of 1 entries

<input type="checkbox"/>	Community	Group	View	Access
<input type="checkbox"/>	public		all	Read-Only

First Previous 1 Next Last

The access right of a community is defined by a group under advanced mode. Configure [SNMP Group](#) to associate a group with a community.

Add Edit Delete

Interface data are as follows.

Configuration Items	Description
Community	Community configuration
Group	Group name
View	View name
Access:	Authority: read only or read-write

2. “Add” the corresponding configuration. “Apply” and finish.

Add Community



The 'Add Community' form contains the following fields and options:

- Community:** A text input field.
- Type:** Radio buttons for 'Basic' (selected) and 'Advanced'.
- View:** A dropdown menu with 'all' selected.
- Access:** Radio buttons for 'Read-Only' (selected) and 'Read-Write'.
- Group:** A dropdown menu.

Buttons: 'Apply' and 'Close'.

16.4.4 User

1. Click the “Management > SNMP > User” in the navigation bar as follows.

User Table

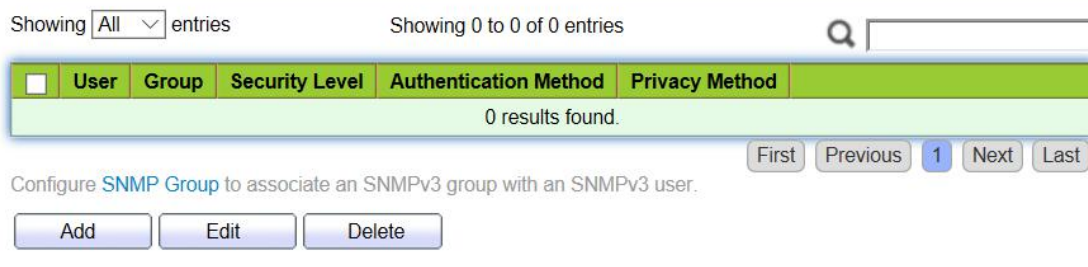

The 'User Table' interface shows a table with the following columns: , User, Group, Security Level, Authentication Method, Privacy Method. Below the table, it displays '0 results found.' and navigation buttons: First, Previous, 1, Next, Last. Below the table, there is a text instruction: 'Configure [SNMP Group](#) to associate an SNMPv3 group with an SNMPv3 user.' and three buttons: Add, Edit, Delete.

Interface data are as follows.

Configuration Items	Description
User	Username
Group	Group name
Security Level	Security level
Authentication Method	Authentication mode
Privacy Method	Encryption mode

2. “Add” the corresponding configuration. “Apply” and finish.

Add User

User

Group

Security Level

- No Security
- Authentication
- Authentication and Privacy

Authentication

Method

- None
- MD5
- SHA

Password

Privacy

Method

- None
- DES

Password

16.4.5 Engine ID

1. Click the “Management > SNMP > Engine ID” in the navigation bar as follows.

Local Engine ID

Engine ID User Defined

(10 - 64 Hexadecimal Characters)

Remote Engine ID Table

Showing entries Showing 0 to 0 of 0 entries

<input type="checkbox"/>	Server Address	Engine ID
0 results found.		

2. Click the “User Automation” to fill in corresponding ID value. “Apply” and finish.

16.4.6 Trap Event

1. Click the “Management > SNMP > Trap Event” in the navigation bar as follows.

Authentication Failure	<input checked="" type="checkbox"/> Enable
Link Up / Down	<input checked="" type="checkbox"/> Enable
Cold Start	<input checked="" type="checkbox"/> Enable
Warm Start	<input checked="" type="checkbox"/> Enable

Interface data are as follows.

Configuration Items	Description
Authentication Failure	Authentication error
Link Up / Down	Port link up/down
Cold start	Cold start
Warm start	Warm start

2. “Apply” and finish.

16.4.7 Notification

1. Click the “Management > SNMP > Notification” in the navigation bar as follows.

Notification Table

Showing entries Showing 0 to 0 of 0 entries

<input type="checkbox"/>	Server Address	Server Port	Timeout	Retry	Version	Type	Community / User	Security Level
0 results found.								

For SNMPv1,2 Notification, [SNMP Community](#) needs to be defined.
 For SNMPv3 Notification, [SNMP User](#) must be created.

Add Notification

Address Type	<input checked="" type="radio"/> Hostname <input type="radio"/> IPv4 <input type="radio"/> IPv6
Server Address	<input type="text"/>
Version	<input checked="" type="radio"/> SNMPv1 <input type="radio"/> SNMPv2 <input type="radio"/> SNMPv3
Type	<input checked="" type="radio"/> Trap <input type="radio"/> Inform
Community / User	private ▾
Security Level	<input checked="" type="radio"/> No Security <input type="radio"/> Authentication <input type="radio"/> Authentication and Privacy
Server Port	<input checked="" type="checkbox"/> Use Default <input type="text" value="162"/> (1 - 65535, default 162)
Timeout	<input checked="" type="checkbox"/> Use Default <input type="text" value="15"/> Sec (1 - 300, default 15)
Retry	<input checked="" type="checkbox"/> Use Default <input type="text" value="3"/> (1 - 255, default 3)

Interface data are as follows.

Configuration Items	Description
Address Type	Address type: "Host Name", "IPv4" or "IPv6"
Server Address	Server address info
Version	SNMP versions: v1, v2 and v3
Type	Notification type: "Trap" or "Inform"
Community / User	Community or username
Security Level	Security level
Server port	162 by default ranging from 1 to 65,535
Timeout	Timeout period: 15s by default ranging from 1 to 300s.
Retry	The retry interval ranges from 1 to 255s with 3s by default.

2. "Add" the corresponding configuration. "Apply" and finish.