

BEFORE FIRST USE

Flushing System

If you are commissioning the system for the first time or have just replaced the filter cartridges, please follow the steps below 4 TIMES to ensure that the system gets adequately flushed before using.

Step 1

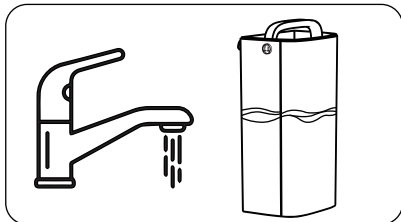

Always start the system flushing with a new tank of the potable (tap) water. Carefully fit the tap water wank back into the tank base and close the cover.

Step 2



Place a large container on the drip tray and have another container ready to alternate.

Step 3

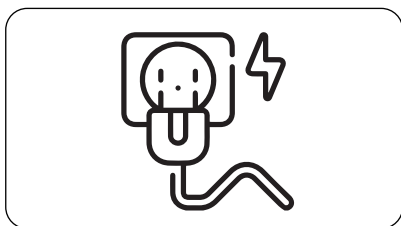

Plug it in, the system will automatically flush the membrane for 30 seconds, then the machine start to water purification. (Membrane flushing is the internal flushing. The flushed water will be returned to the tap water tank with no water out of the water spout.)

Step 4



Filtering – the system will automatically start to filter and transfer the pure water to the internal pure water reservoir. Wait for about 5 mins until the filtering indicator light 「」 turns off, which means that the internal pure water reservoir is full.

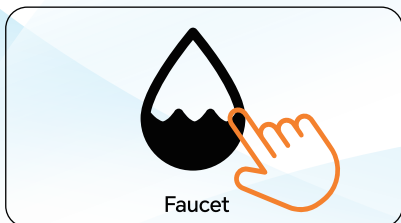

Step 5

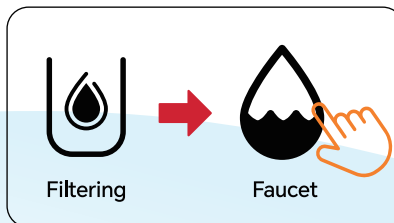

Empty the internal pure water reservoir to flush – Long press the 「」 button: the pure water will start to flow from the outlet until the internal reservoir is empty.

Step 6



The system will continue to filter when the internal pure water reservoir is empty. Waiting until the 「」 indicator light turns off again and long press 「」 again to empty the internal pure water reservoir.

Step 7

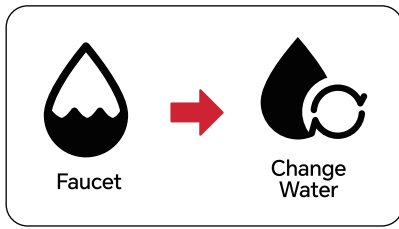

Continue repeating the steps 4-6 to flush the water purifier until the 「」 Indicator lights on during flushing.

Step 8

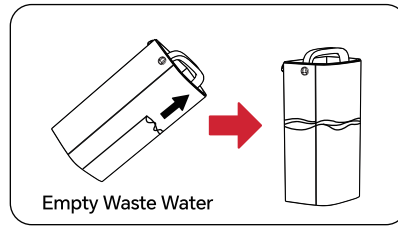

Emptying the remaining waste water in the Tap Water Tank when the 「」 indicator lights on, refill it with fresh water, and continue repeating the steps 4-7. Then You can enjoy fresh pure water.

Note: The PPM number displayed on the control panel represents the TDS (Total Dissolved Solids) value of the filtered water. Water with a TDS value below 50 ppm is safe for drinking.

Activate Mineral Filter

Step 1

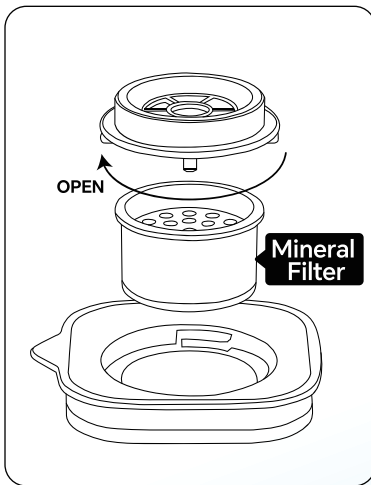

Take out the mineral filter and shake it a few times to evenly distribute the mineral balls inside.

Step 2

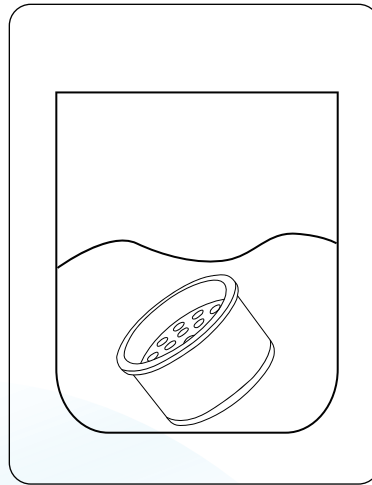

Soak it for 2-3 hours to ensure optimal flow.

Step 3



Re-install the mineral filter and enjoy your healthy mineral water.

Note: Due to high flow rate, do not use 「」 to dispense mineral water to avoid overflow.

Any Questions? Contact us

 +1(866)-387-8668 (Mon-Fri 10:00 AM-4:00 PM PST)

 support@stokkfilter.com

Thank you for choosing us, enjoy your prime water purifier!